



Unvan: CKR Optic Light Ayd. San. A.Ş.

Web Adresi: www.opticlight.com.tr

Posta: info@opticlight.com.tr

Tel: +90 850 811 96 70

Adres: Cevizli Mah. Tugay Yolu Cad. Ofisim Istanbul Plaza A Blok
No:20/41 Maltepe / İSTANBUL

Company Name: CKR Optic Light Ayd. San. A.Ş.

WebAddress: www.opticlight.com.tr

Mail: info@opticlight.com.tr

Tel: +90 850 811 96 70

Address: Cevizli Mah. Tugay Yolu Cad. Ofisim İstanbul Plaza A
Blok No:20/41 Maltepe/İSTANBUL



*Optik Lensler / Optical Lenses

*Reflektör / Reflector



product summary

ÜRÜN KATALOGLARI

1. Outdoor lighting Series / Dış mekan aydınlatma serisi

5050 Modüler Lens Serisi 5050 module lens series	P2-P14	Ayakkabı kutusu ışıklı lens serisi Shoebox light lens series	P23-P25
9090 Modüler Lens Serisi 9090 module Lens series	P15-P17	Güneş sokak lambası lens serisi Solar street lamp lens series	P26
Sokak lambası modülü lens serisi Lamp module lens series	P18-P22	Duvar lambası lens serisi Wall lamp lens series	P27

2. Industrial lighting series / Endüstriyel aydınlatma serisi

UFO yüksek defne lambası lens serisi UFO mining lamp lens series	P28-P29	Endüktif UFO ışık madencisi lamba lensi serisi Inductive UFO light series	P31
DOB UFO yüksek tavan lambası lens serisi DOB UFO mining lamp series	P30		

3. Indoor lighting Series / İç aydınlatma serisi

Optik reflektör serisi Optical reflective cup series	P32-P35	COB lens serisi COB lens series	P48-P49
Tavan lambası lens serisi Ceiling light lens series	P36-P37	Ultra ince COB lens serisi Ultra-thin COB lens series	P50-P53
Çizgi ışıklı lens serisi Line light lens series	P38-P41	Sahne ışığı lens serisi Stage light lens series	P54-P55
Izgara ışık lensi serisi Grille lamp lens series	P42-P43	İç mekan aydınlatma lensi serisi GU10/MR11/MR16	P56-P57
LED çizgi ışığı lens serisi LED Line light lens series	P44-P45	İki renkli downlight lens serisi Two-color downlight lens series	P58-P59
Parasoley serisi Anti-glare cover series	P46-P47		

4. Customized scheme / Özelleştirilmiş çözümler

5050 LED Optik Linzeleri Serisi

5050 led optical lens series



Multiple angles / Çeşitli açılar

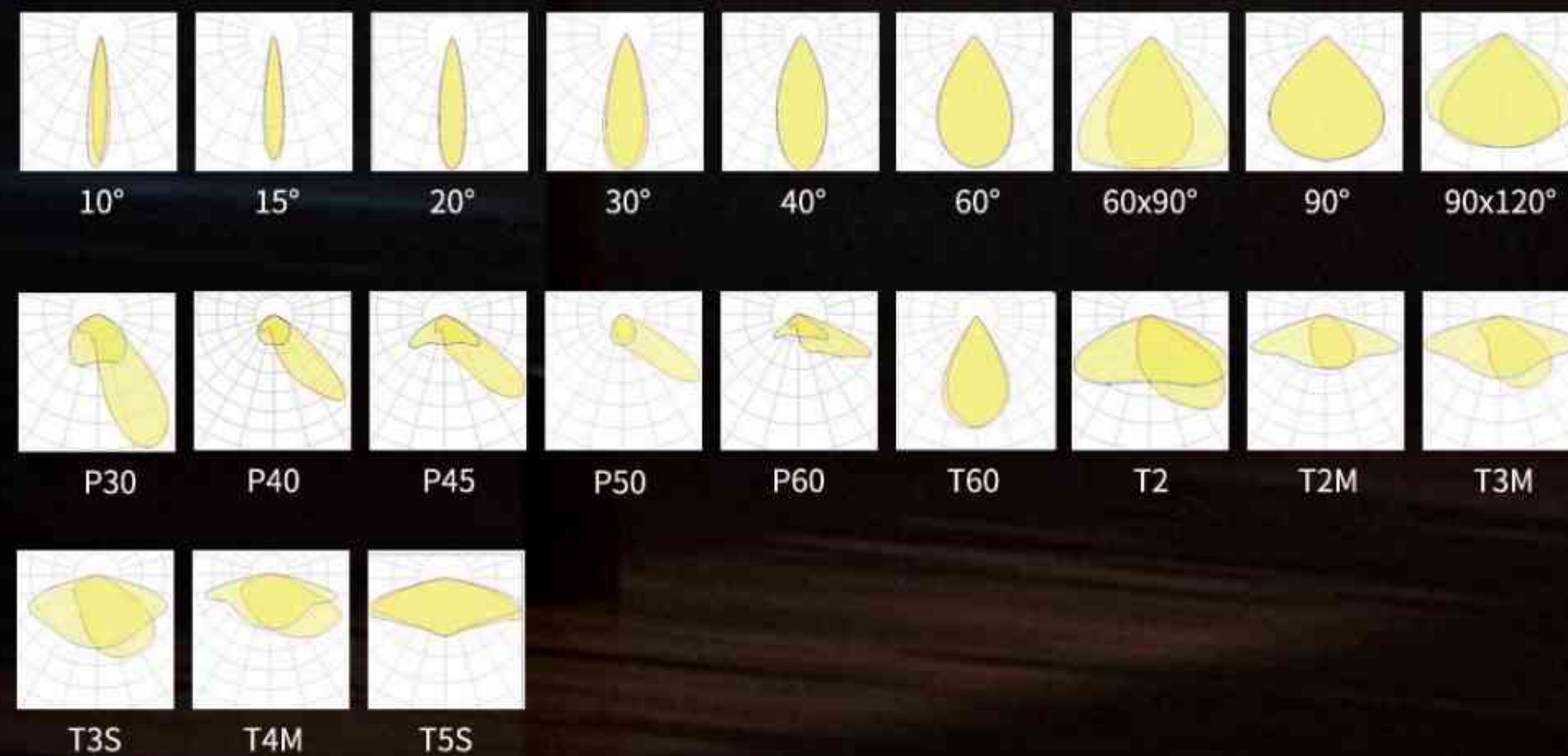

HZ-5050-4H1-10/30D-3535

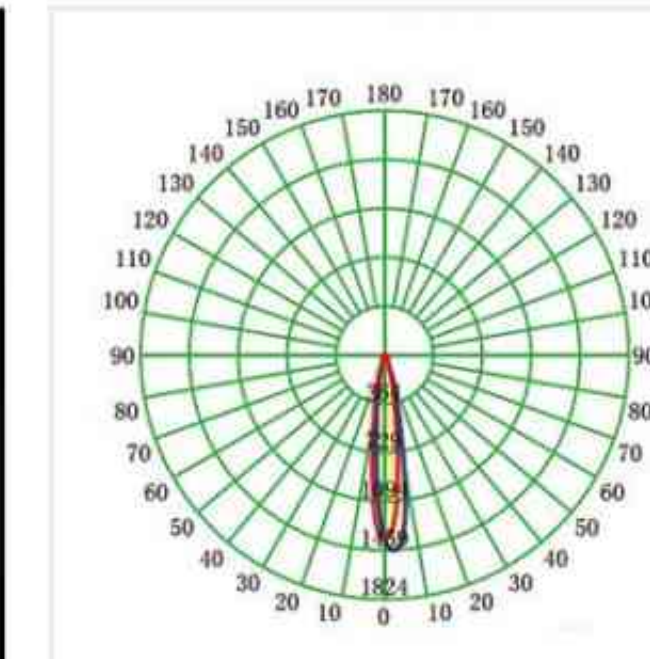

HZ-5050-4H1-10D-3535

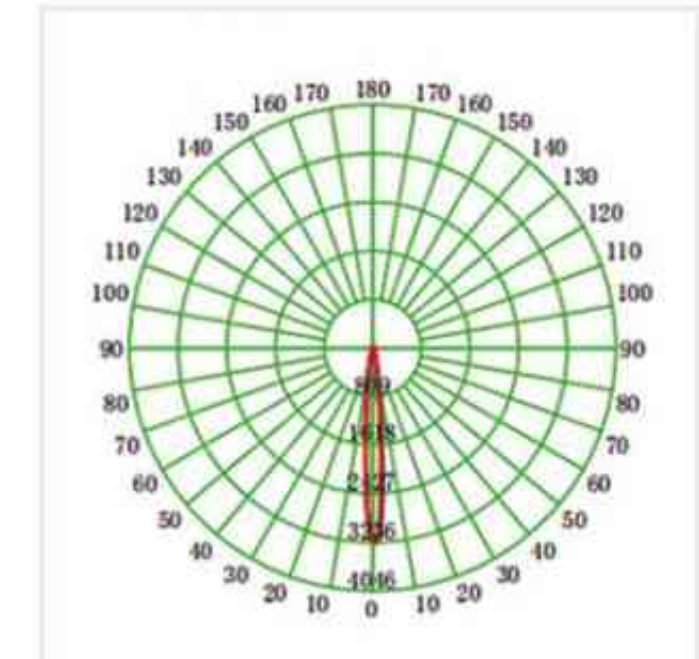

HZ-5050-4H1-15D-5050

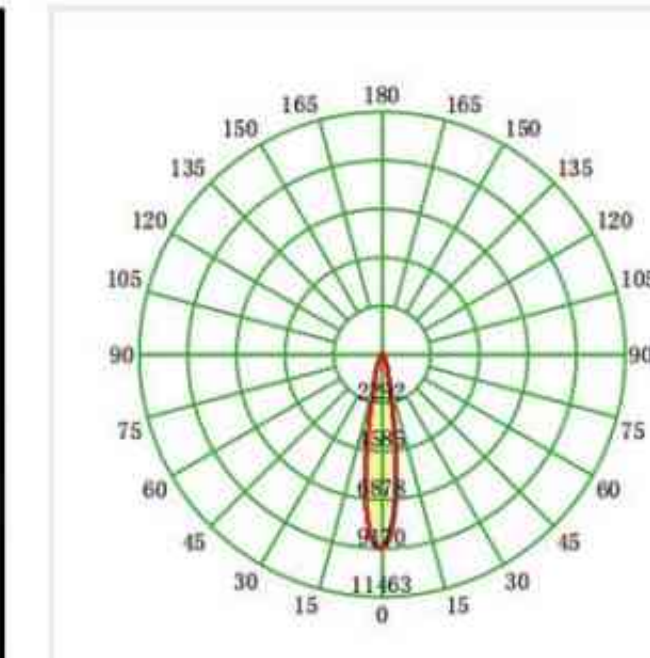

HZ-5050-4H1-30D-5050

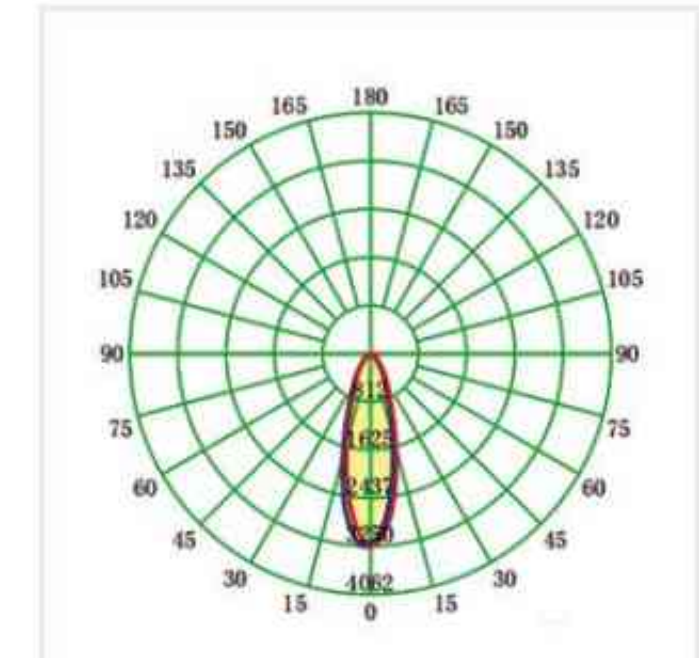

HZ-5050-4H1-P50D-3535/5050

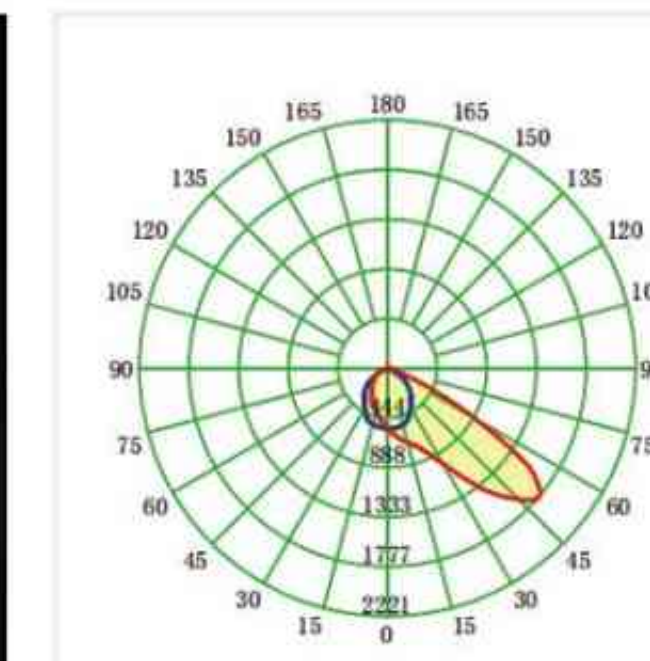

HZ-5050-4H1-P60D-5050

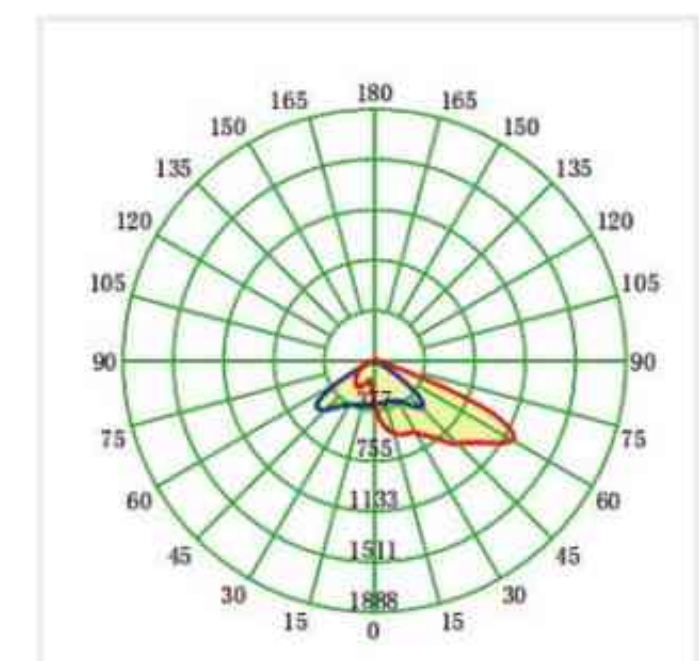

HZ-5050-4H1-P60D-3535/5050

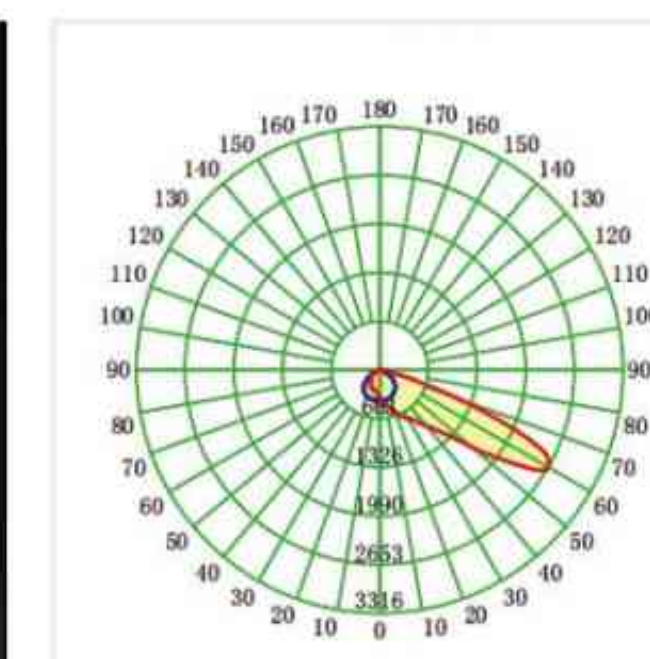

HZ-5050-4H1-P60D-5050

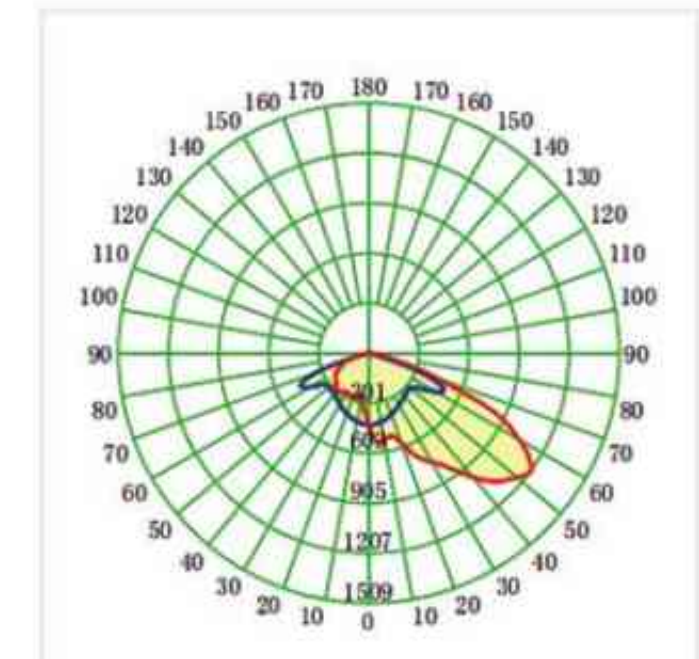

HZ-5050-4H1-60/T60/90D-3535/5050

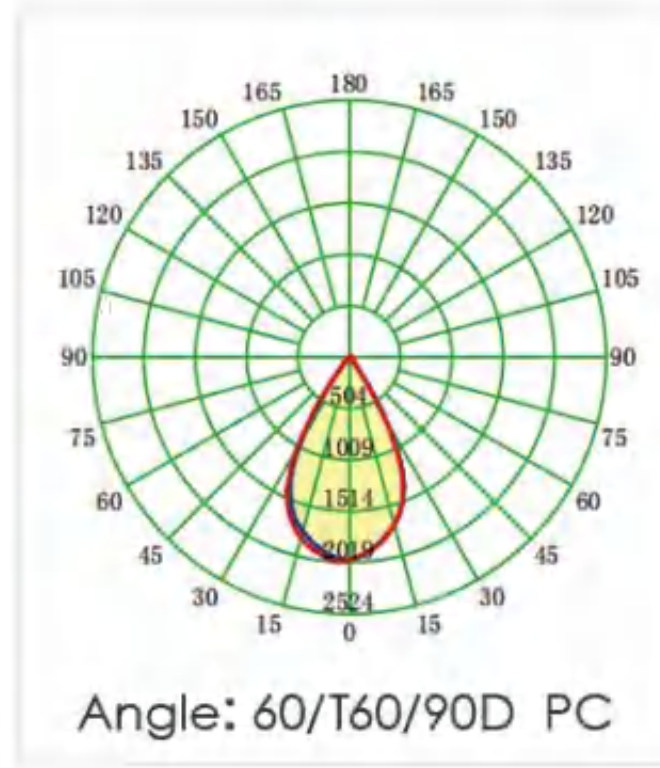

HZ-5050-4H1-60x60/90x90D-3535

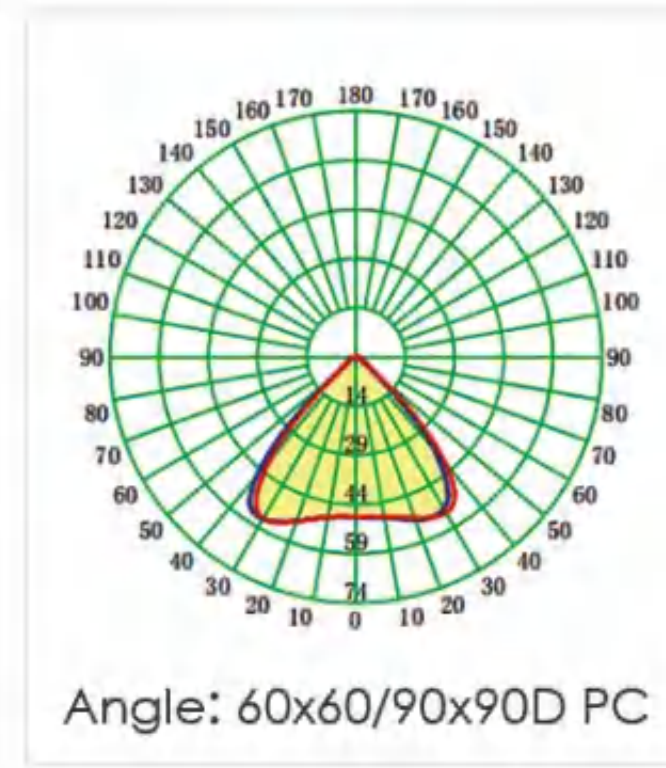

HZ-5050-4H1-TPIIS-4x3030

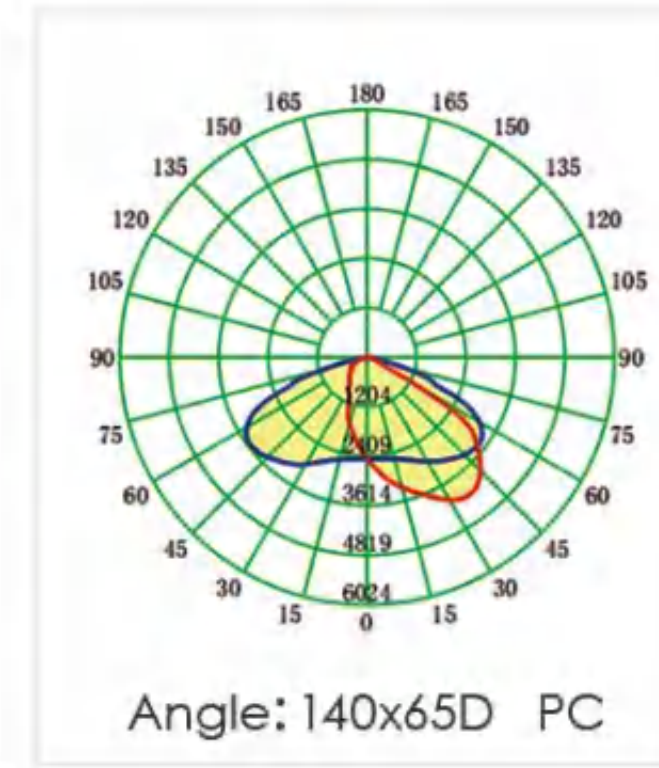

HZ-5050-4H1-T2M-Cutoff-5050

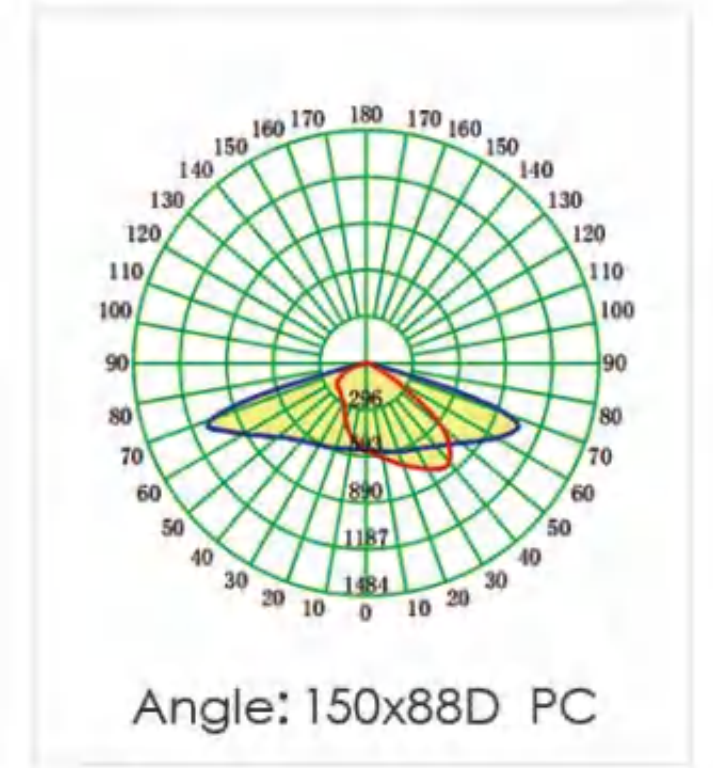

HZ-5050-4H1-60x90/90x120D-5050

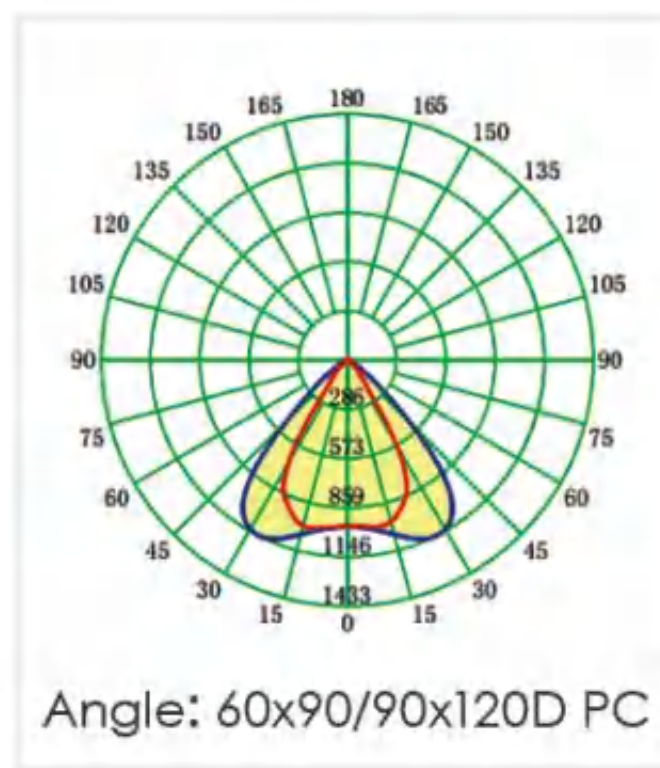

HZ-5050-4H1-TII-5050

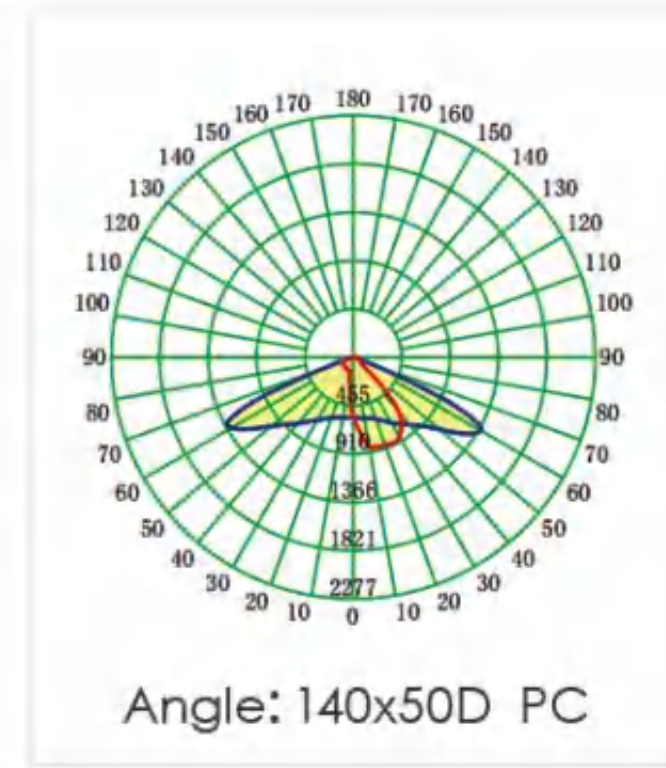

HZ-5050-4H1-TIIM-5050

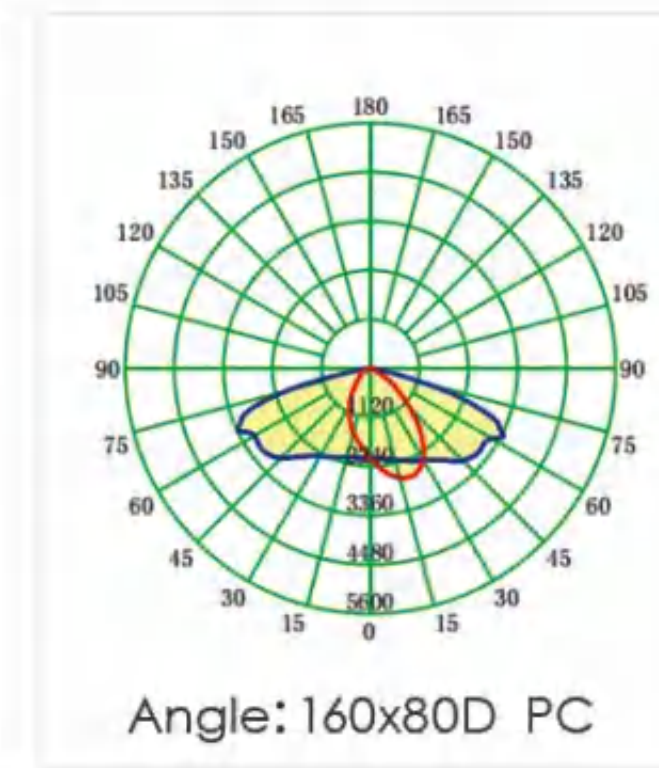

HZ-5050-4H1-TPII-5050

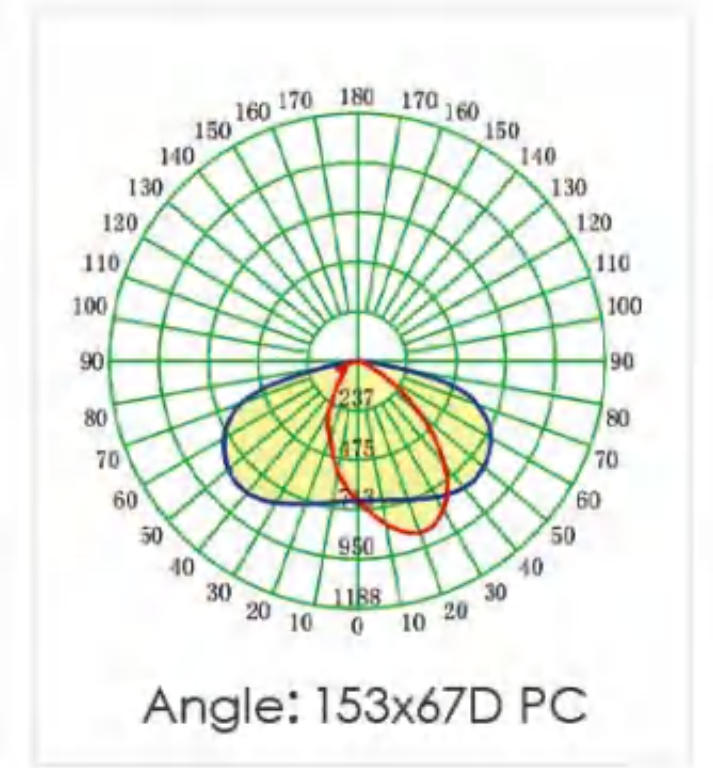

HZ-5050-4H1-TII-Waterproof-5050

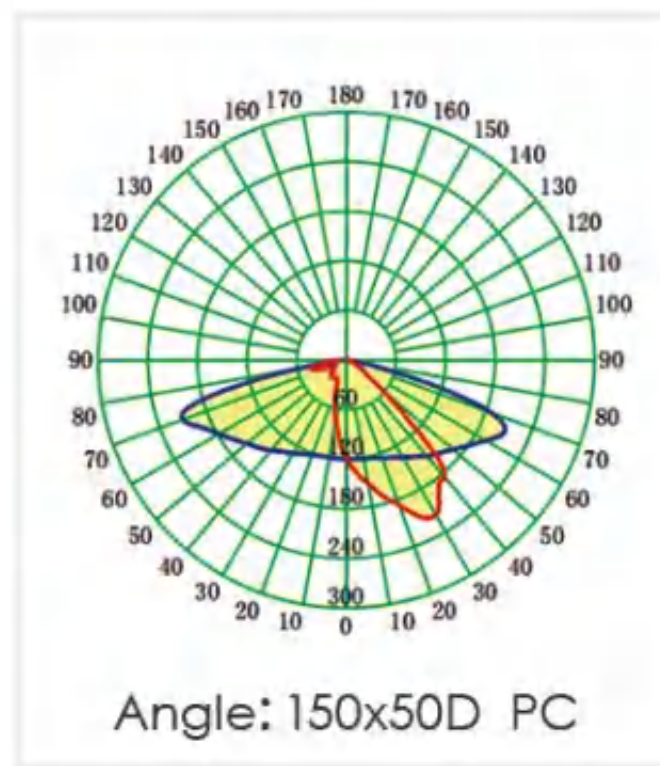

HZ-5050-4H1-TII-5050

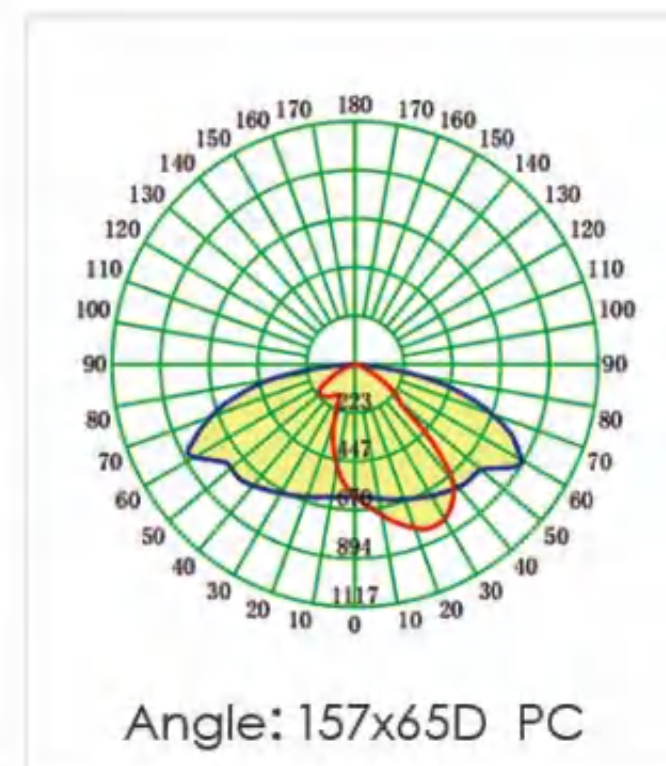

HZ-5050-4H1-T2M-5050

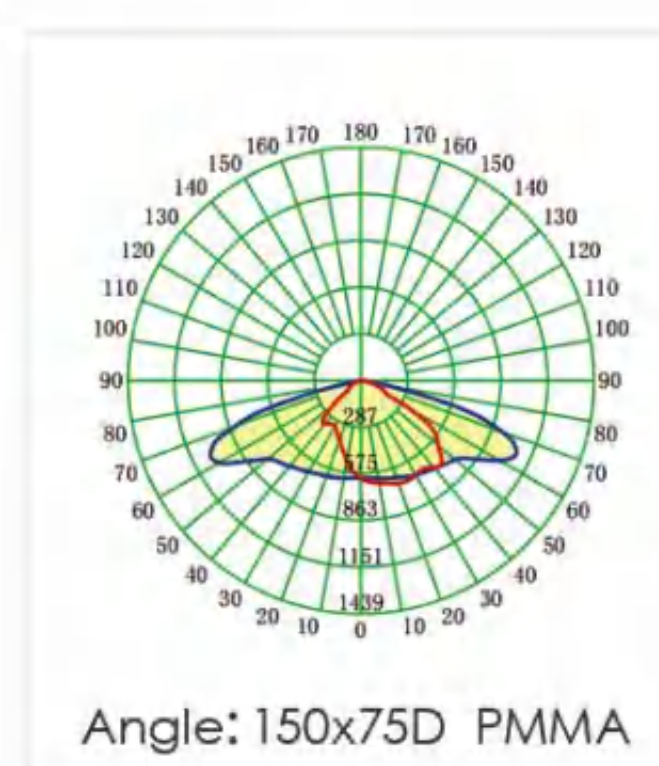

HZ-5050-4H1-TPYE2M-5050

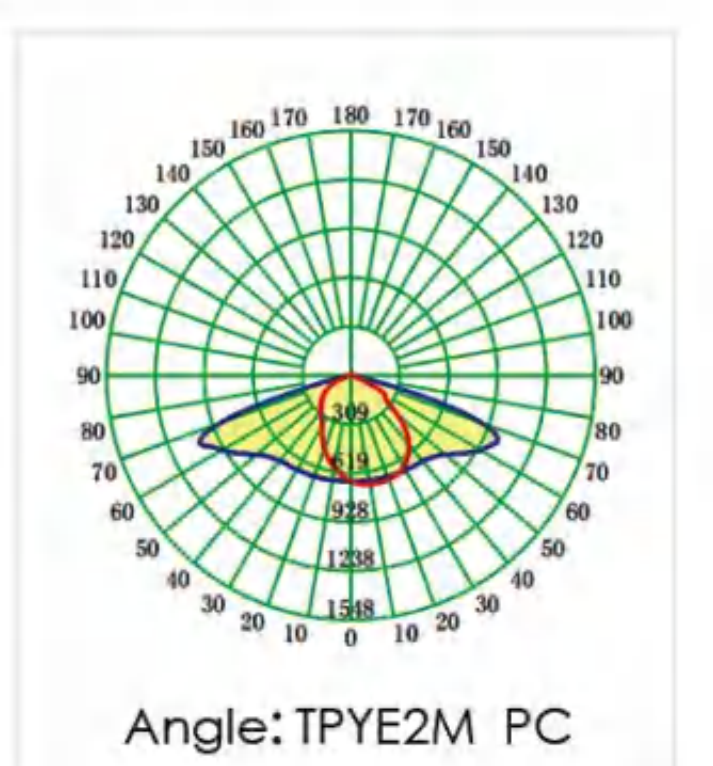

HZ-5050-4H1-TIIM-Cutoff-5050

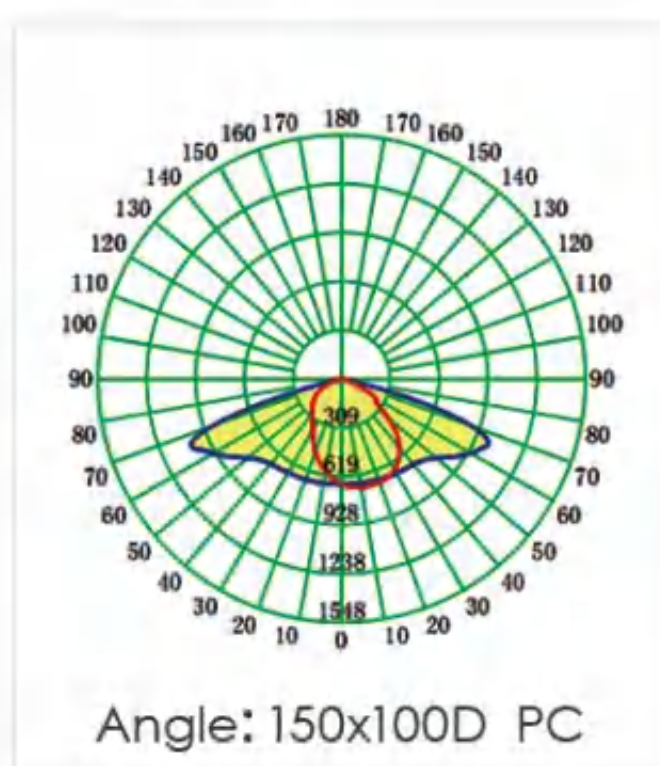

HZ-5050-4H1-TIIM-5050

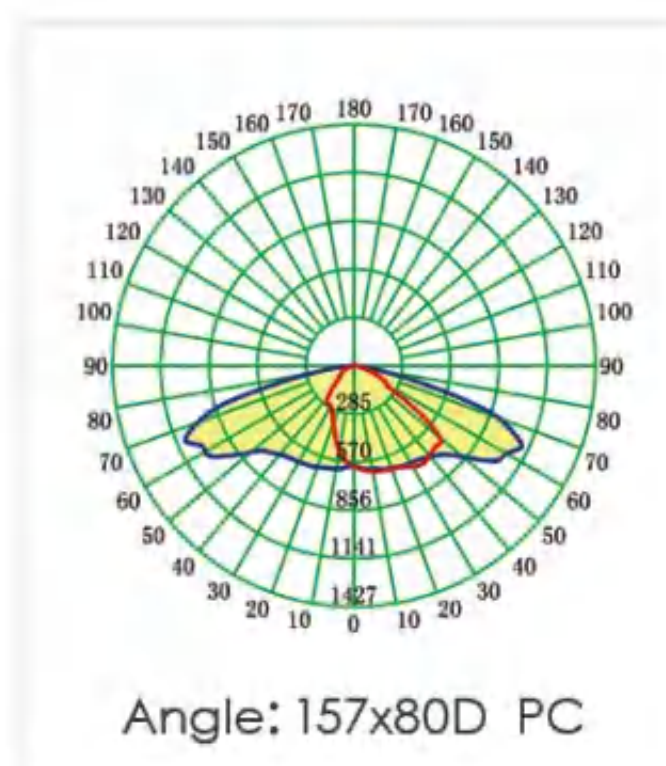

HZ-5050-4H1-TIII-4x3030

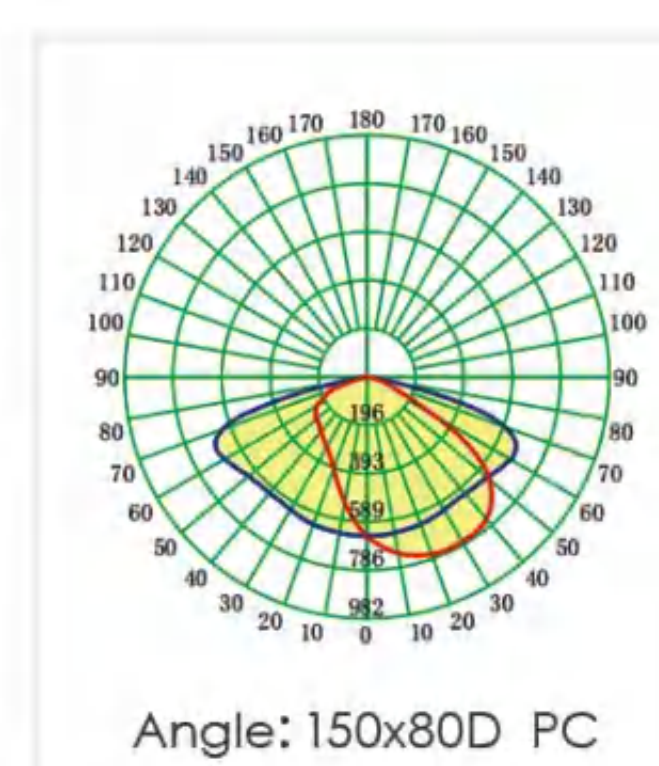

HZ-5050-4H1-TIIM-5050

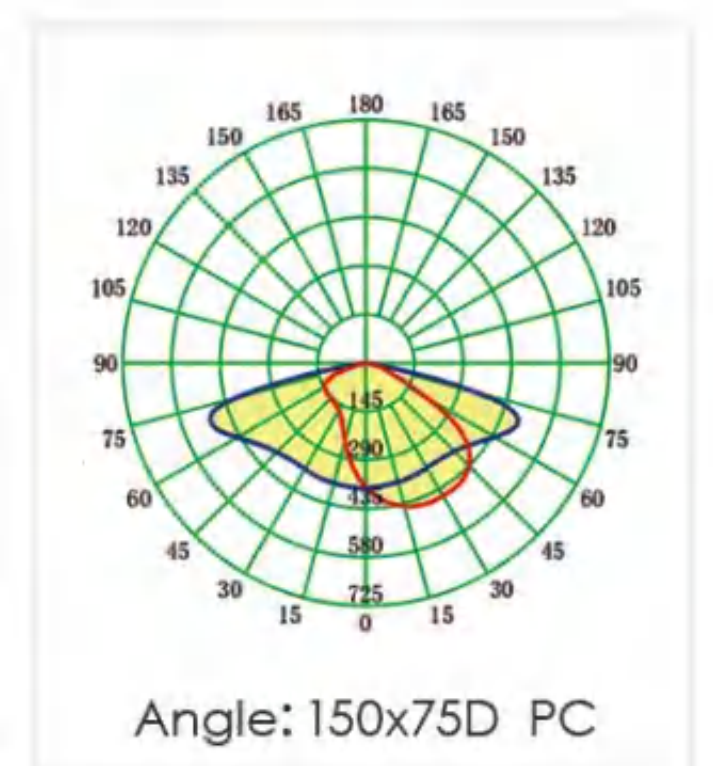

HZ-5050-4H1-T4M-5050

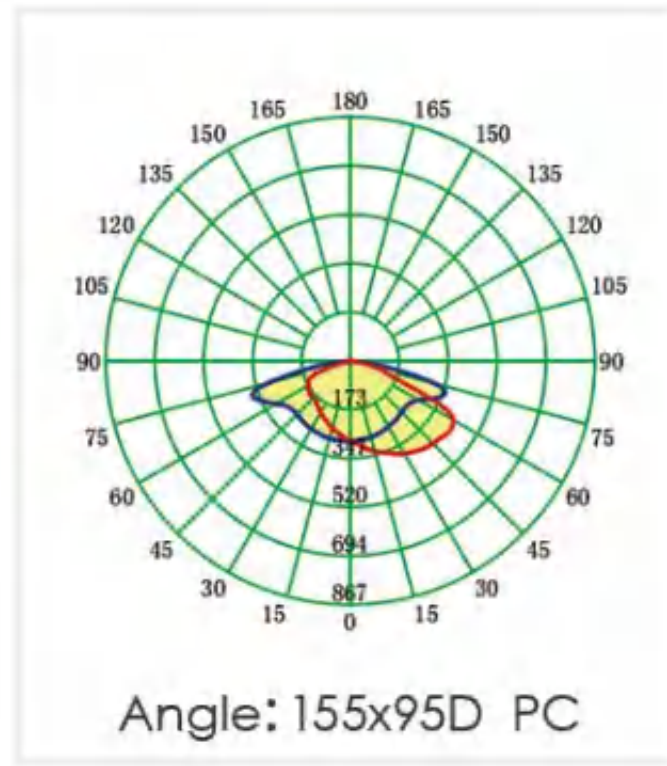

HZ-5050-4H1-T5-5050

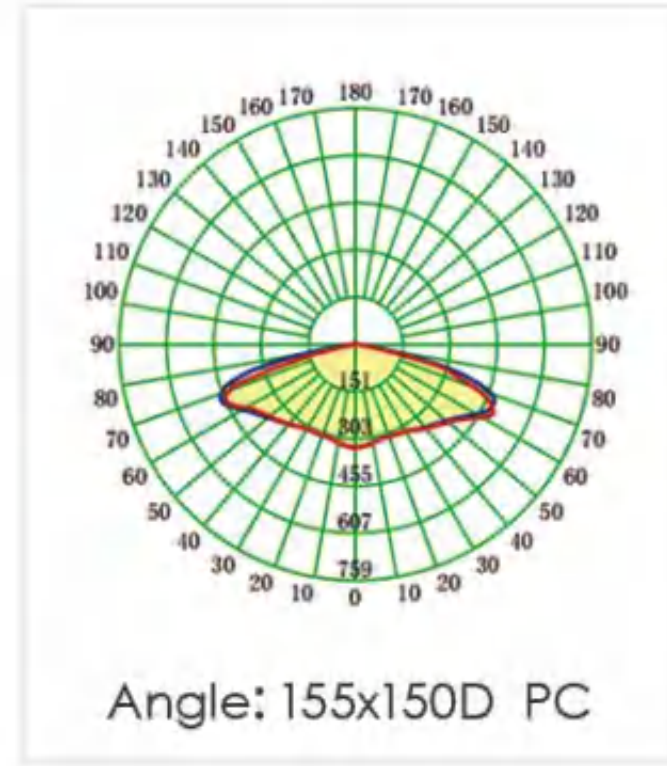

HZ-5050-6H1-60x90/90x120D-5050

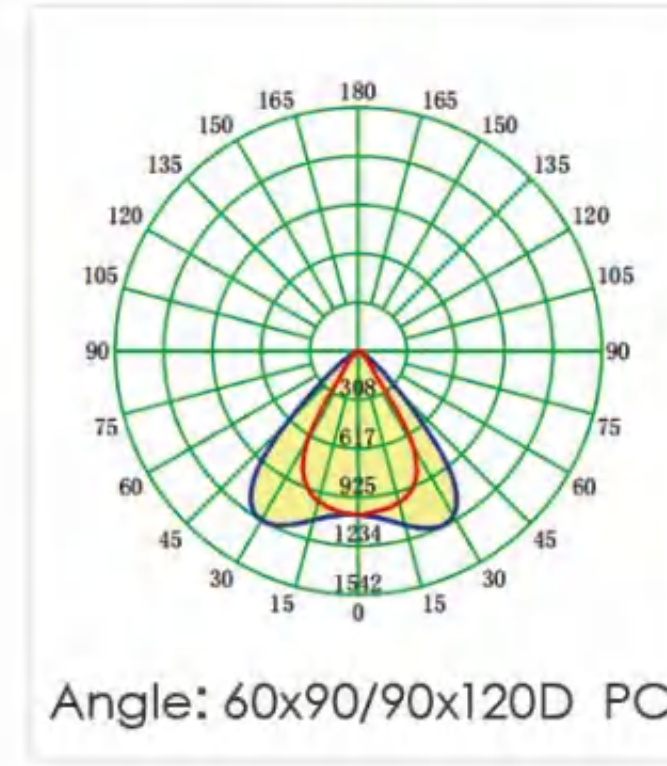

HZ-5050-6H1-P45D-3030/5050

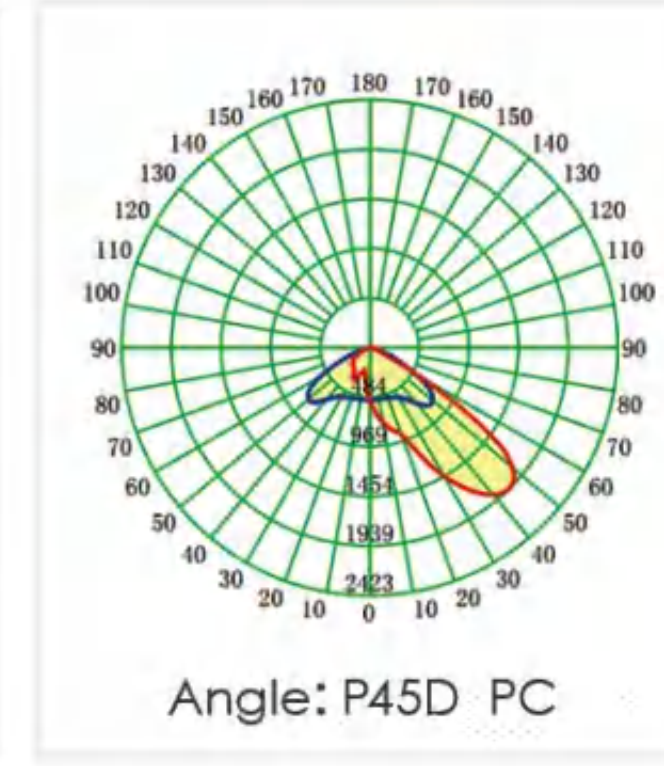

HZ-5050-6H1-15D-5050

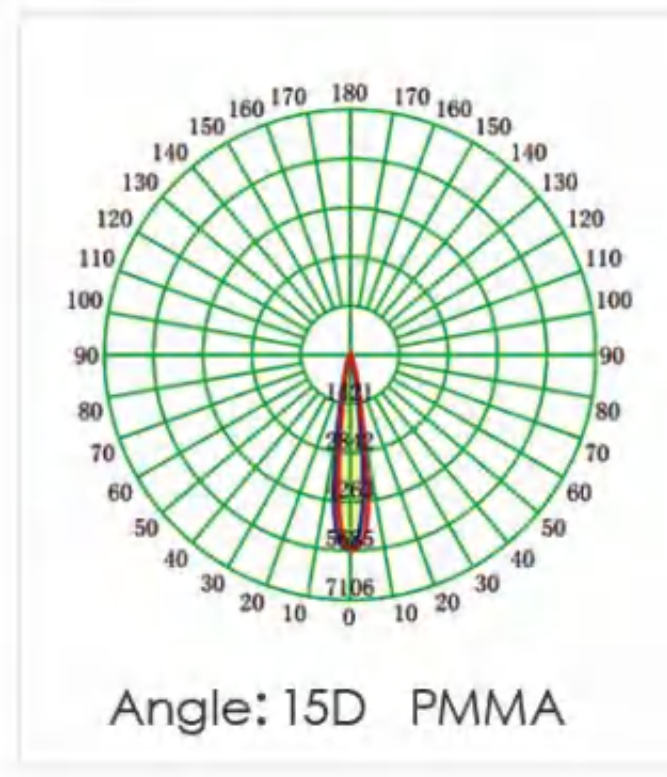

HZ-5050-6H1-T1M-5050

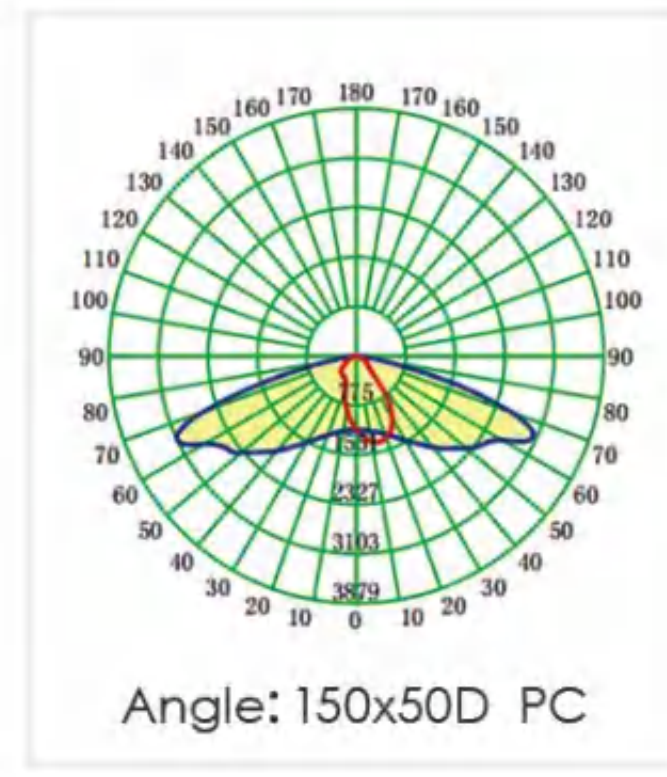

HZ-5050-6H1-T1M-5050

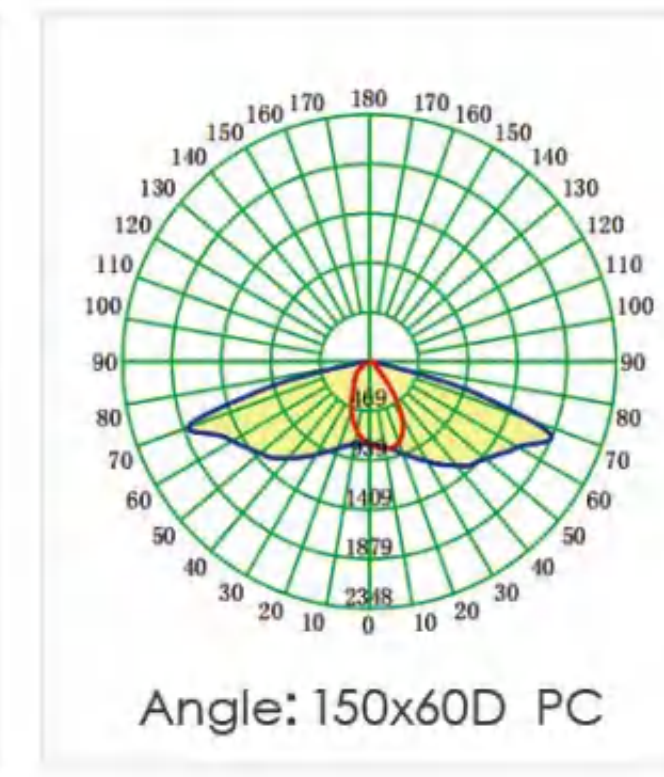

HZ-5050-6H1-25D-5050

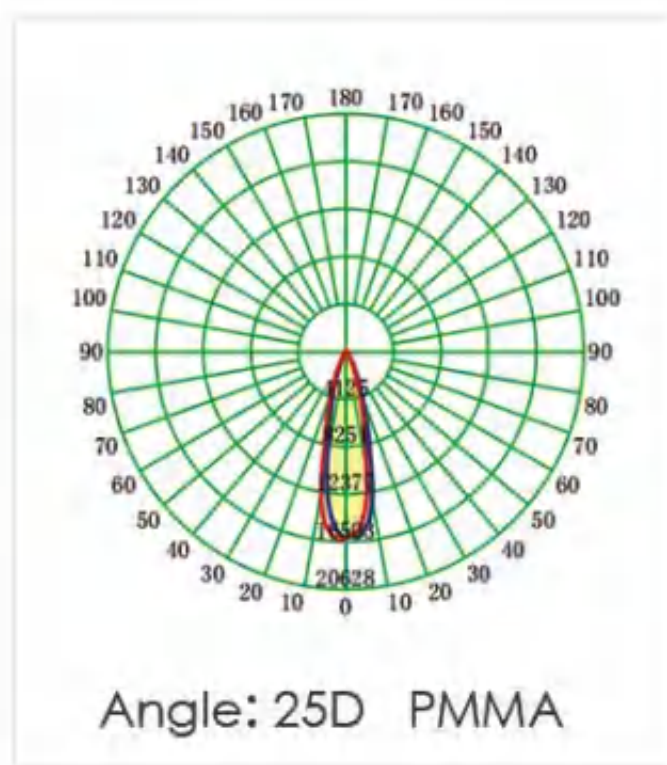

HZ-5050-6H1-30D-3030/5050

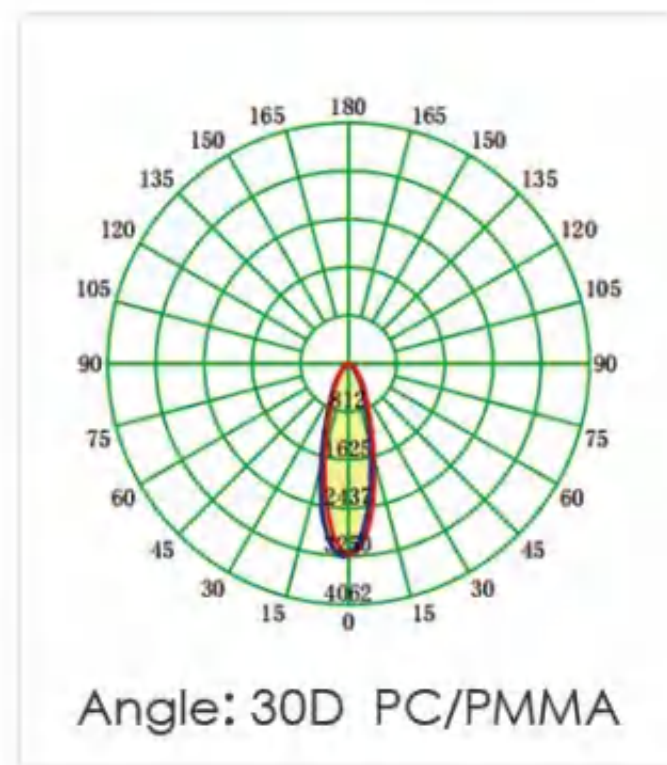

HZ-5050-6H1-T1IS-Cutoff-5050

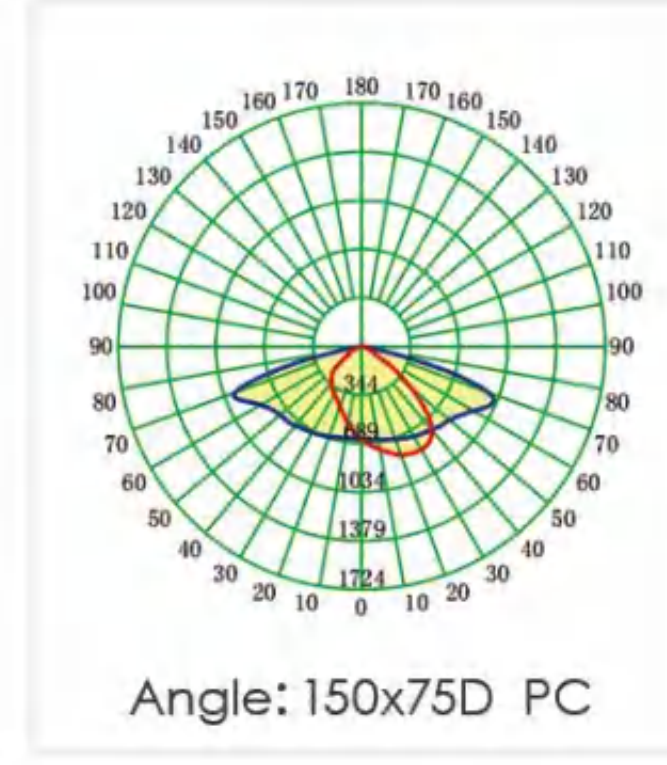

HZ-5050-6H1-T1IM-Cutoff-5050

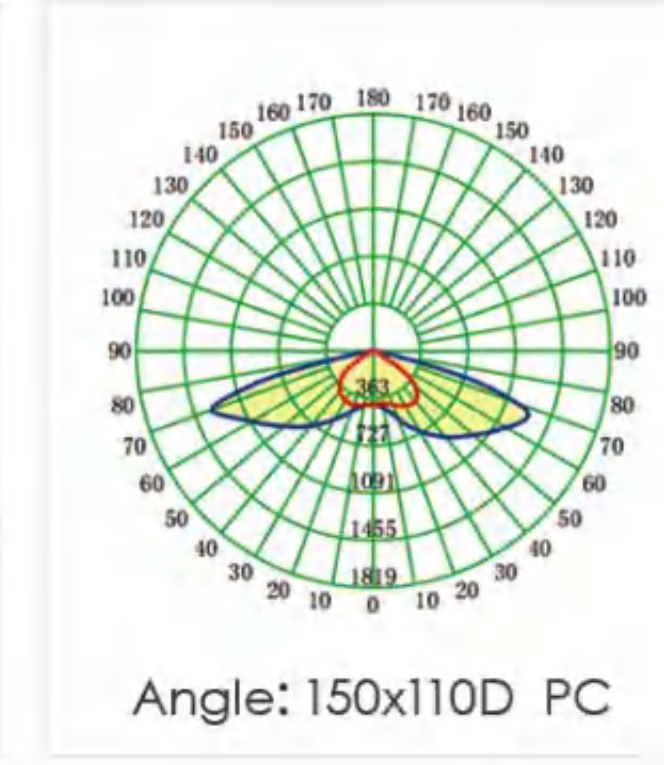

HZ-5050-6H1-60D2-5050

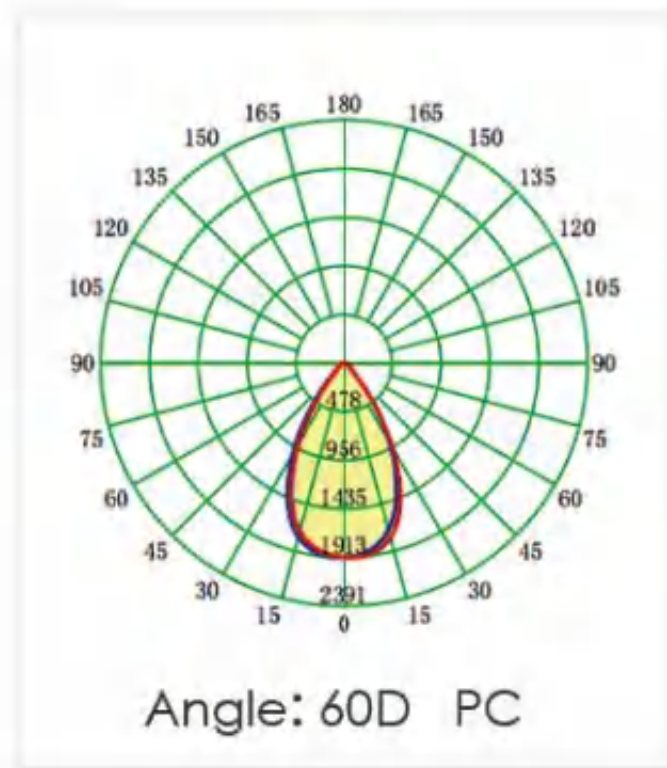

HZ-5050-6H1-60/90/120D-5050

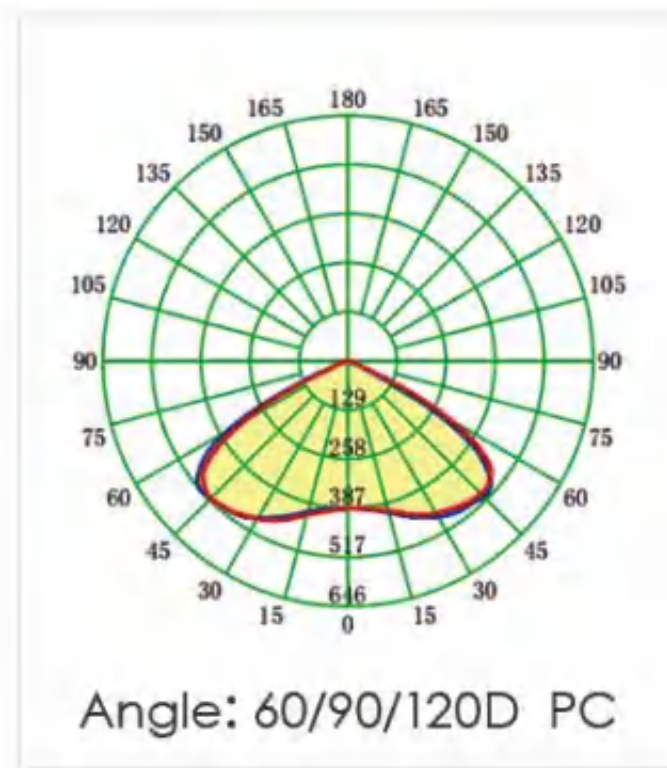

HZ-5050-6H1-TYPE2M-5050

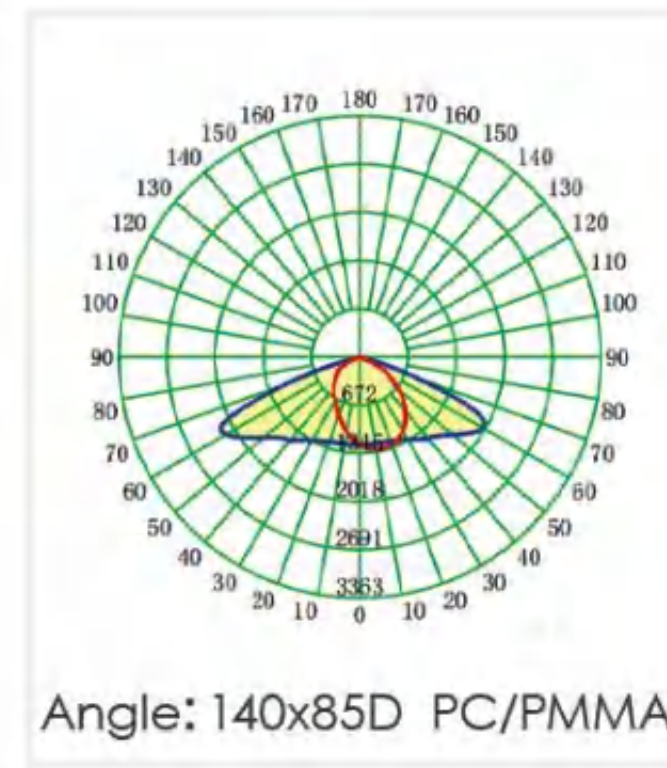

HZ-5050-6H1-TYPE2M-5050

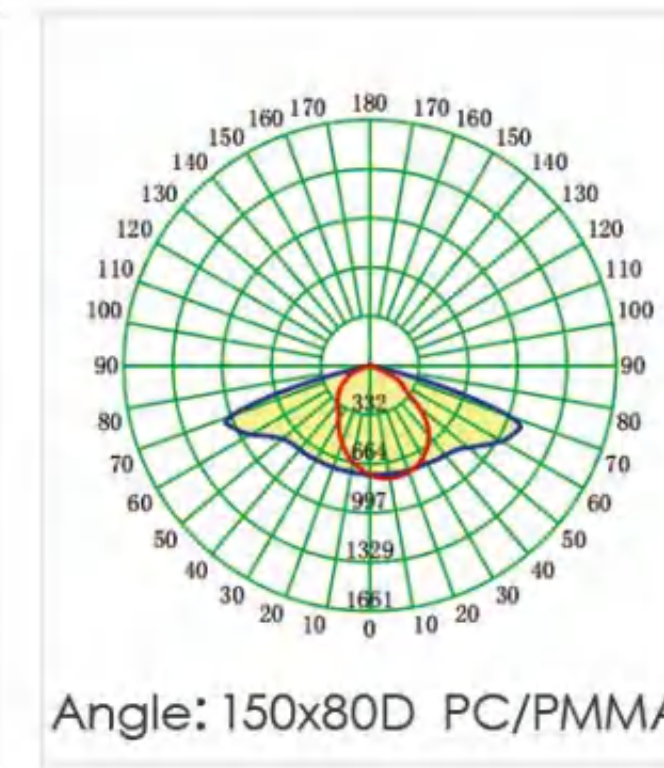

HZ-5050-6H1-TIIM-5050

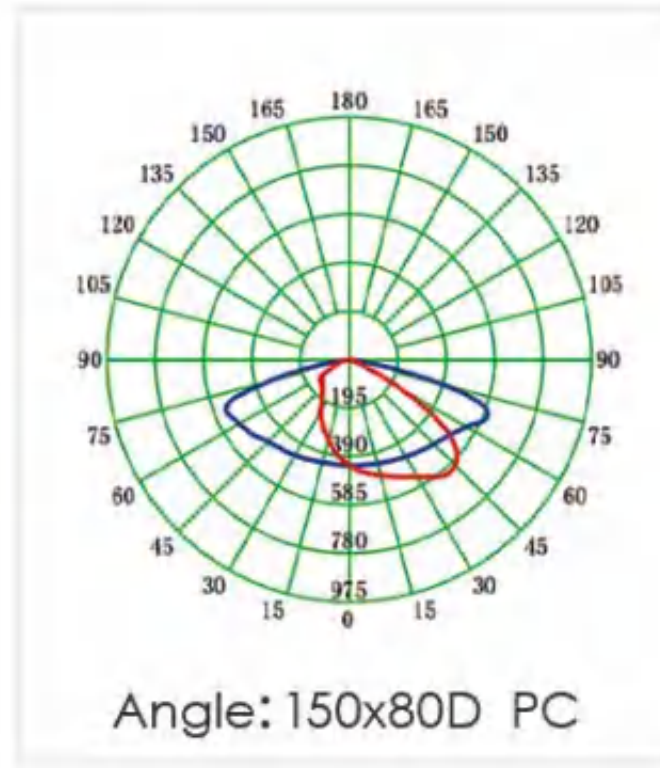

HZ-5050-6H1-T3M-5050

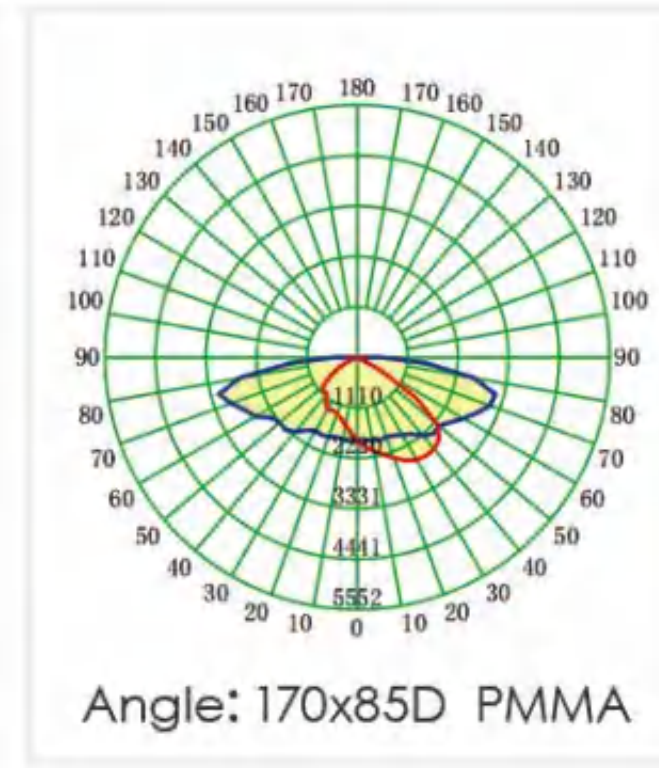

HZ-5050-8H1-60x90/90x120D-5050

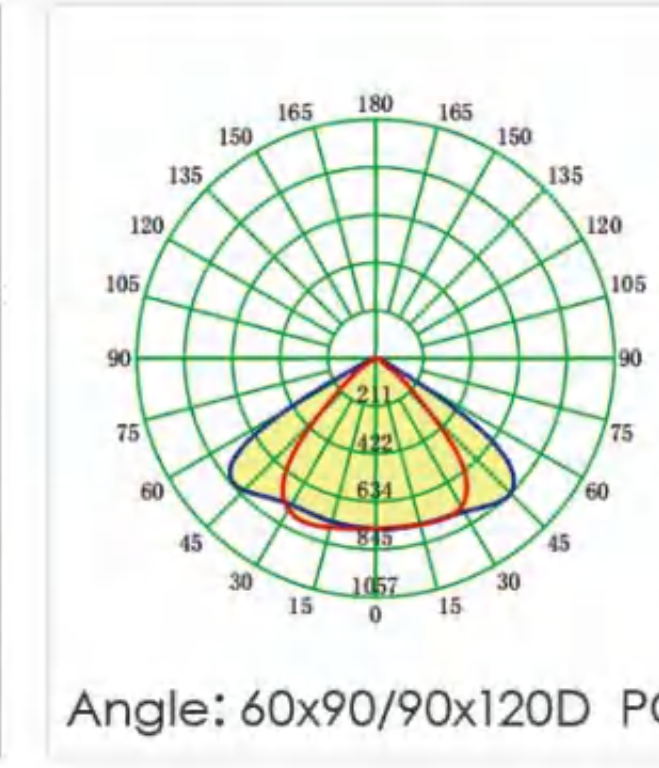

HZ-5050-8H1-P45D-5050

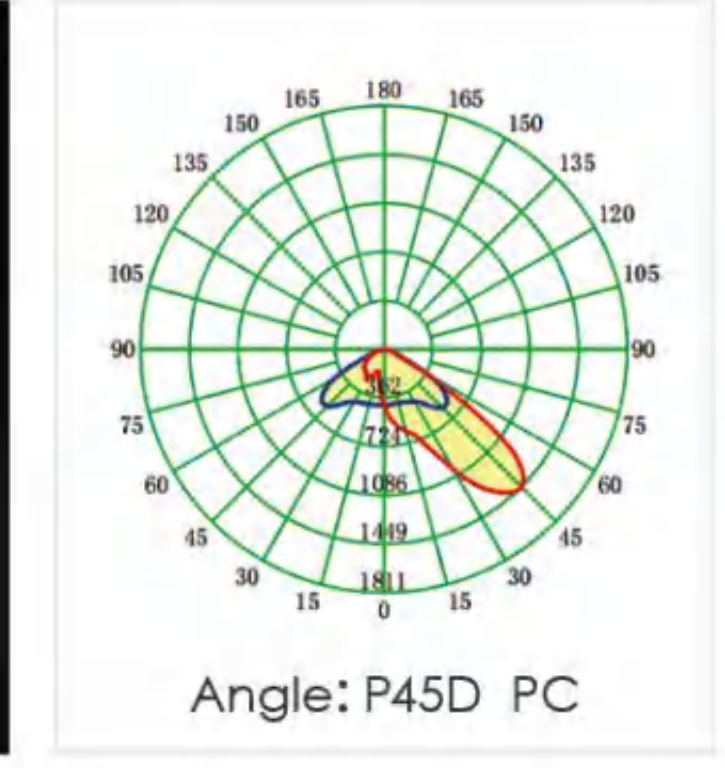

HZ-5050-6H1-T4M-5050

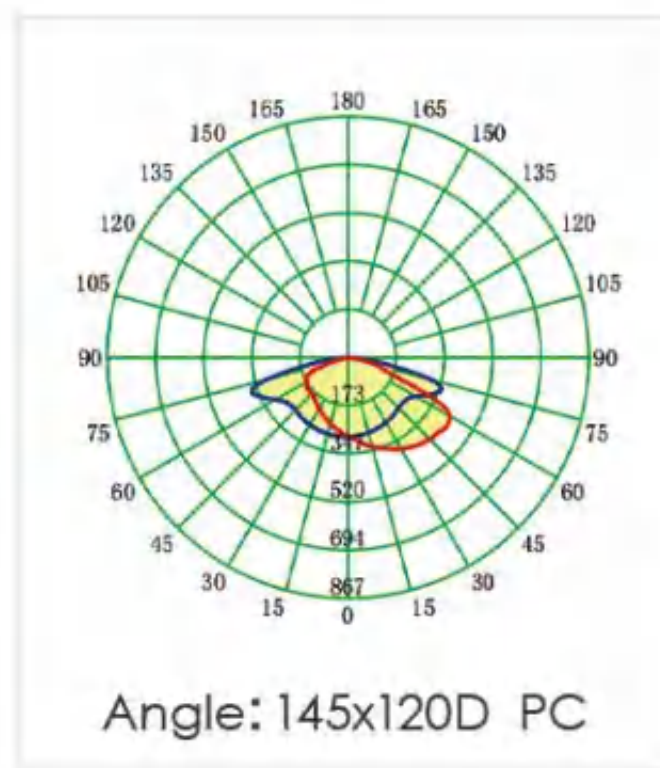

HZ-5050-6H1-T5-5050

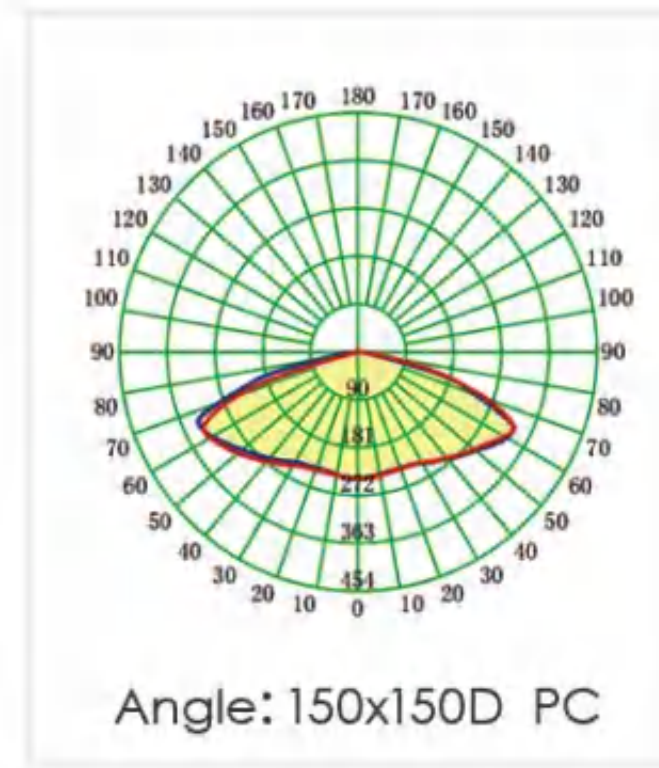

HZ-5050-8H1-T2-3535

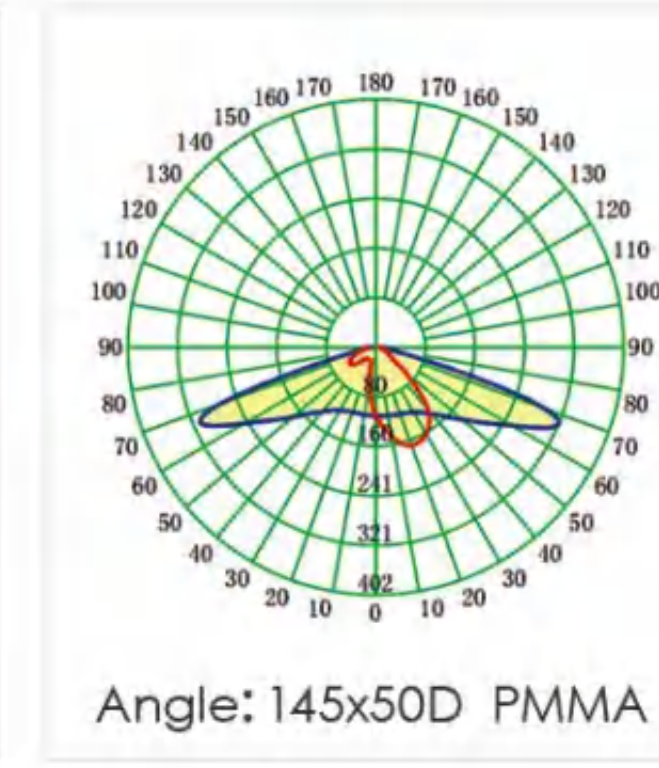

HZ-5050-8H1-T3-3535

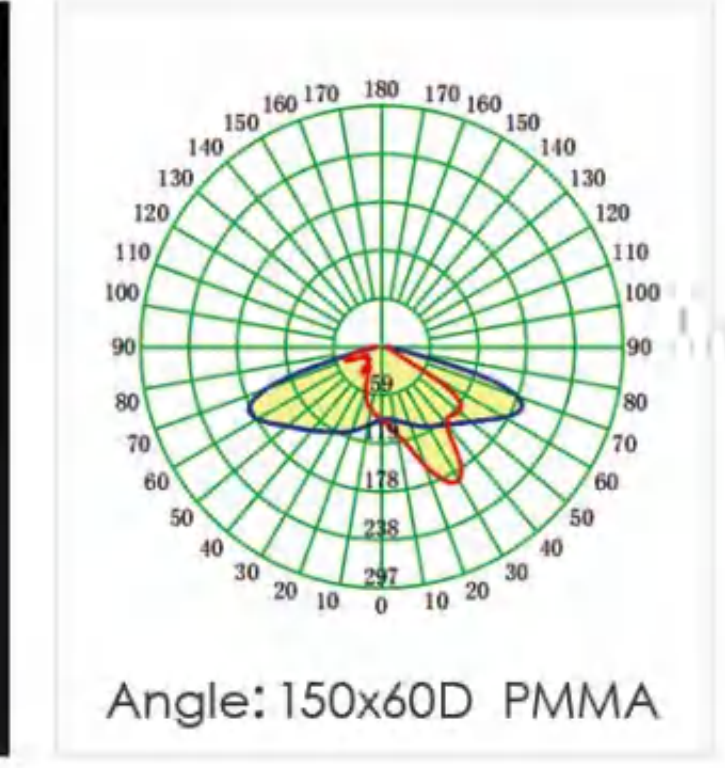

HZ-5050-8H1-15D-3535

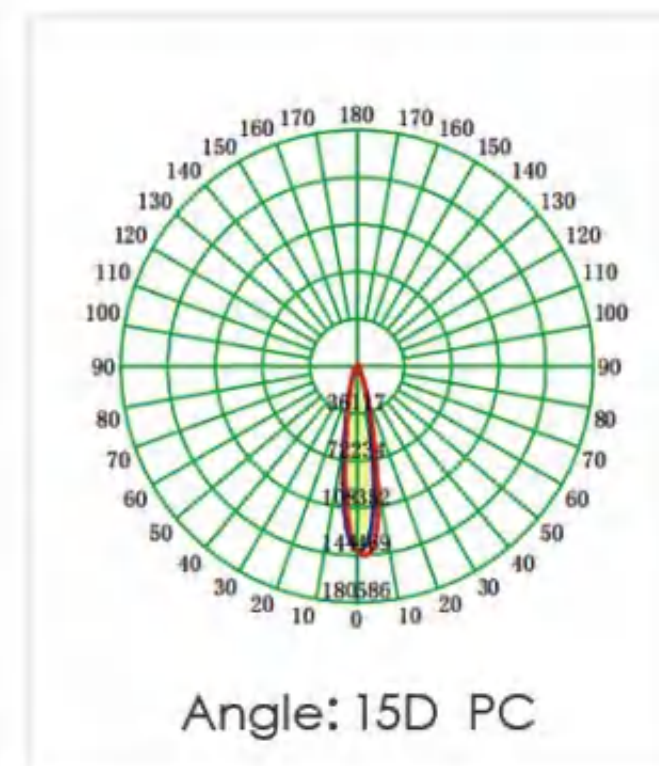

HZ-5050-8H1-TPIIM-Cutoff-5050

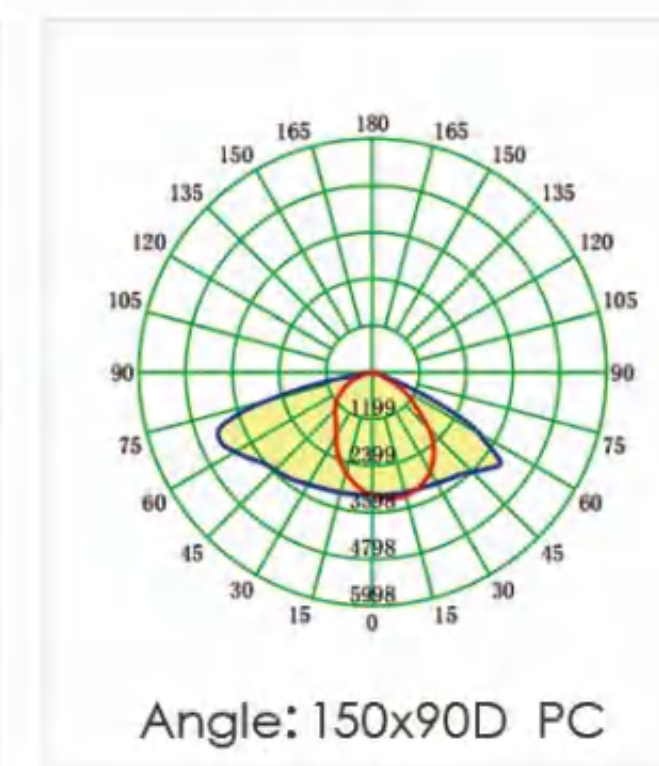

HZ-5050-8H1-TPIIM-Cutoff-5050

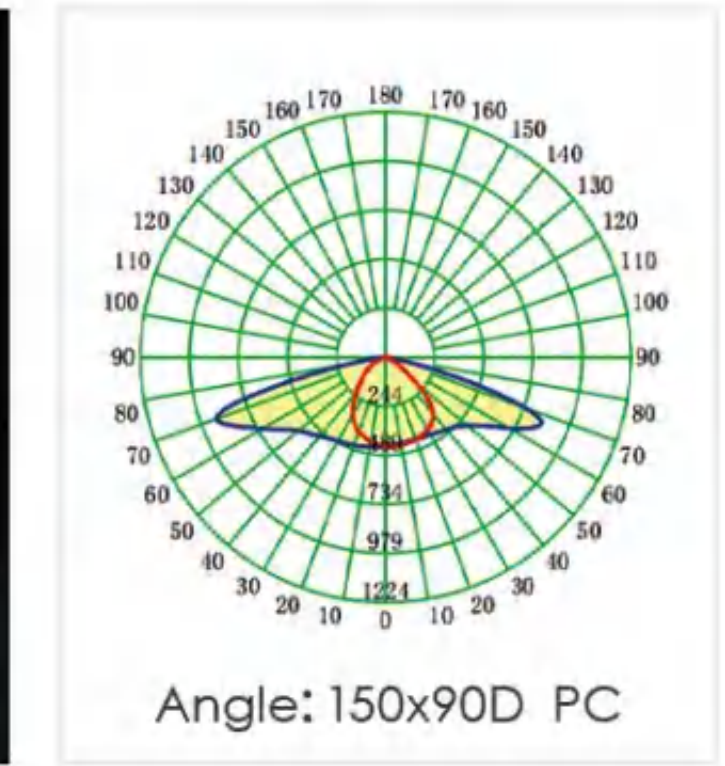

HZ-5050-8H1-30D/30D2-5050

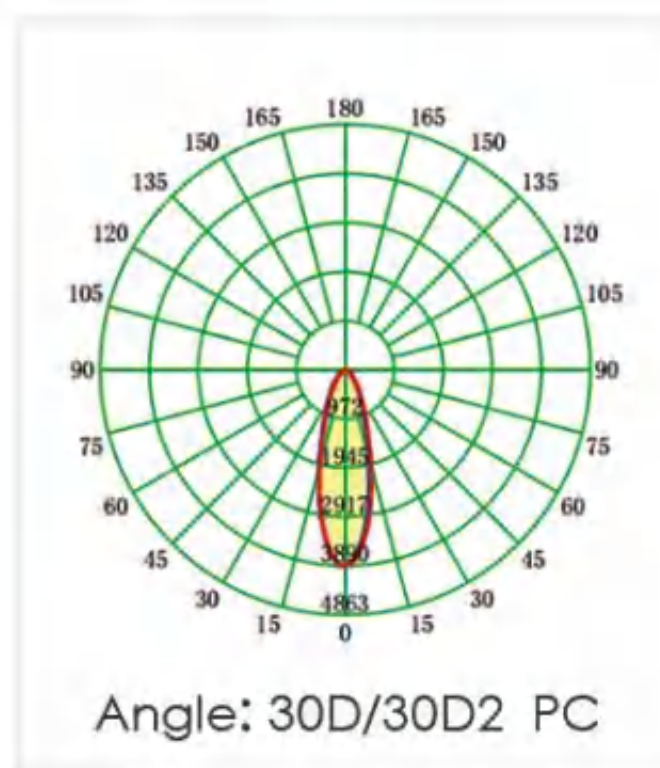

HZ-5050-8H1-60/90D-5050

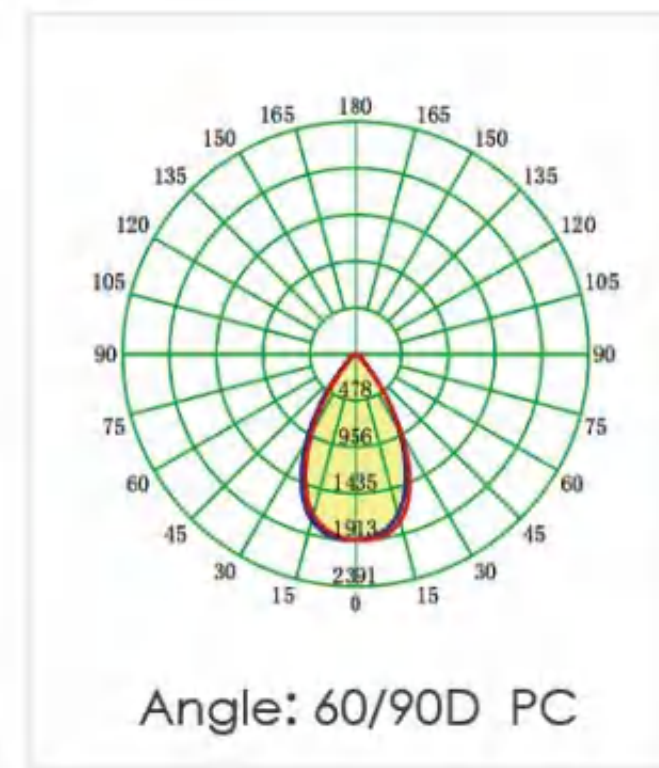

HZ-5050-8H1-TIIM-5050

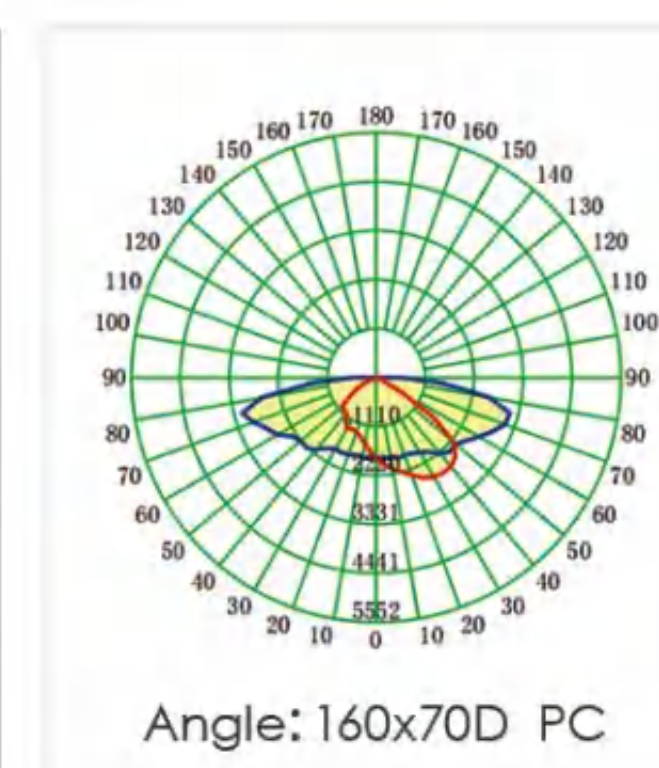

HZ-5050-8H1-T4M-5050

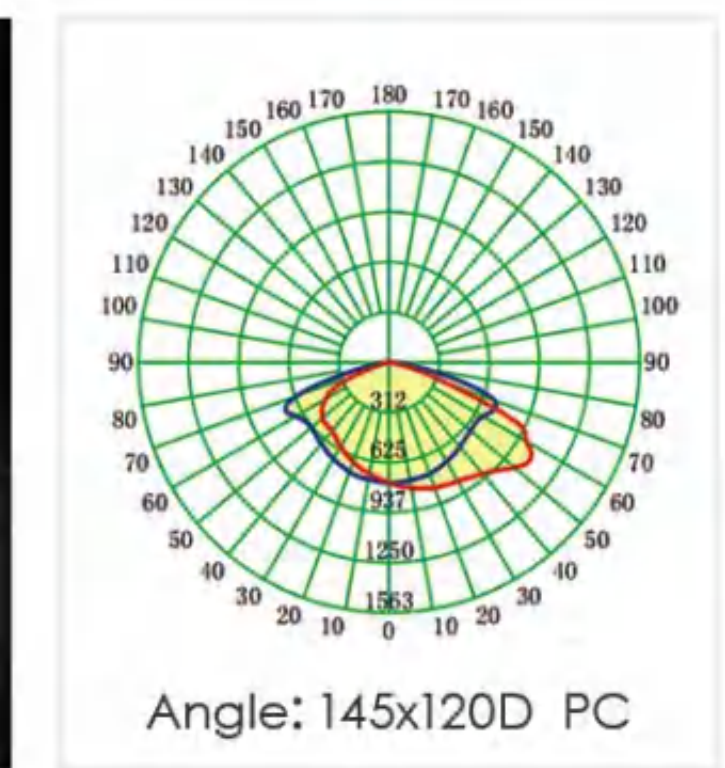

HZ-5050-8H1-T5-5050

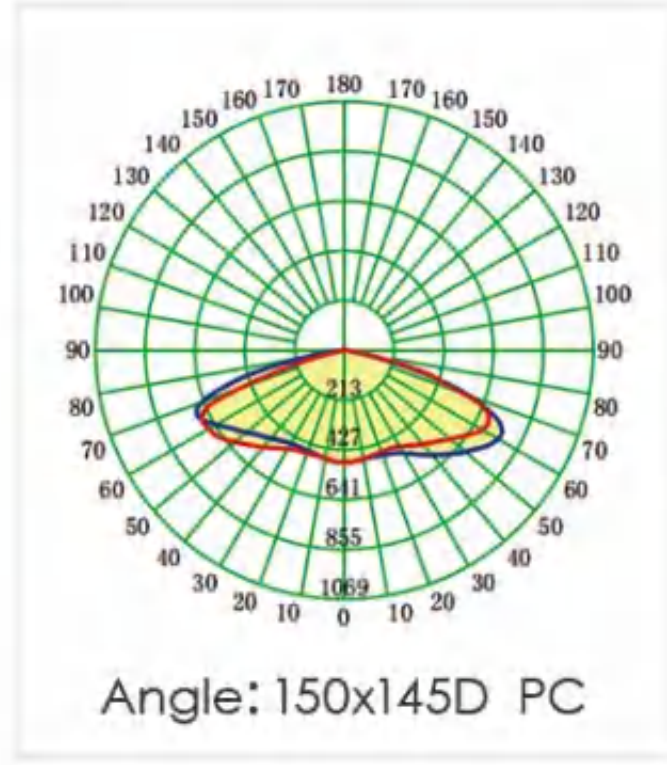

HZ-5050-8H1-HV-3030

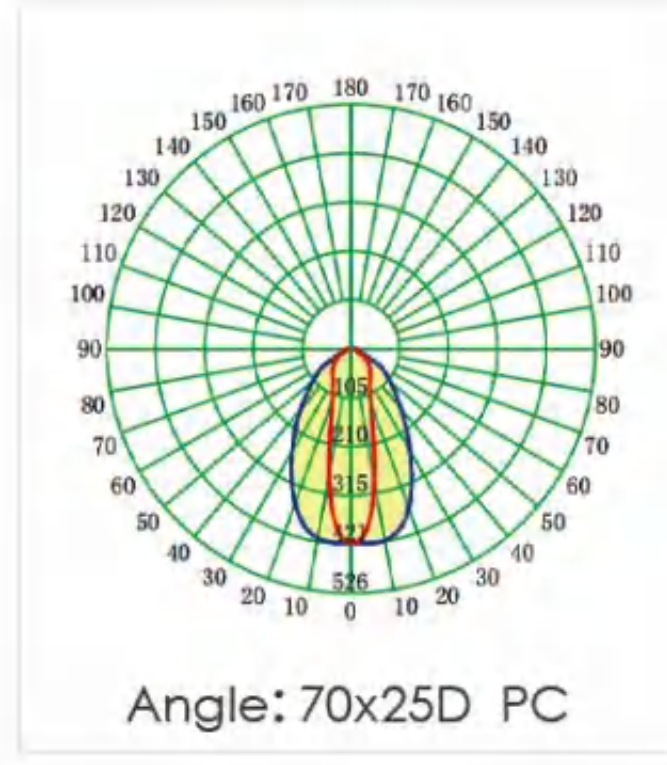

HZ-5050-12H1-TPIIM-Cutoff-3030

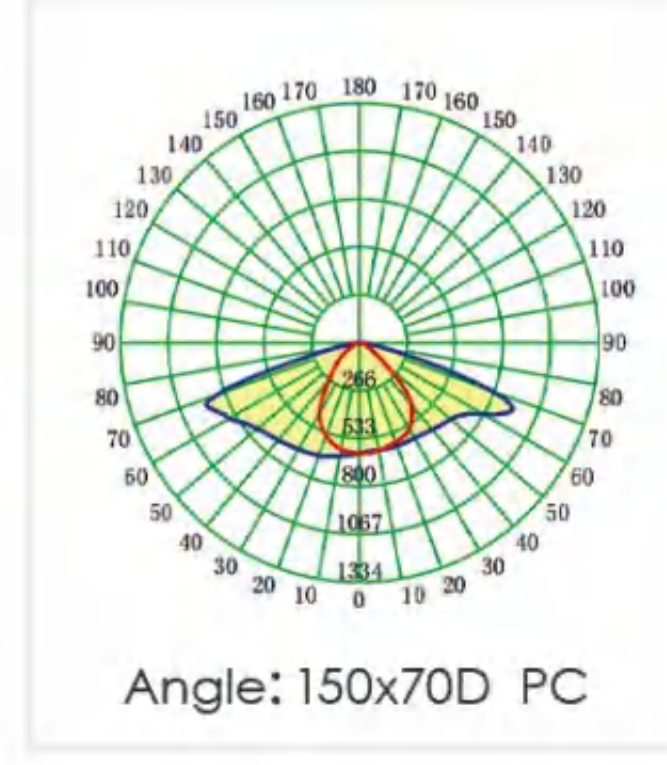

HZ-5050-12H1-TIIM-3030

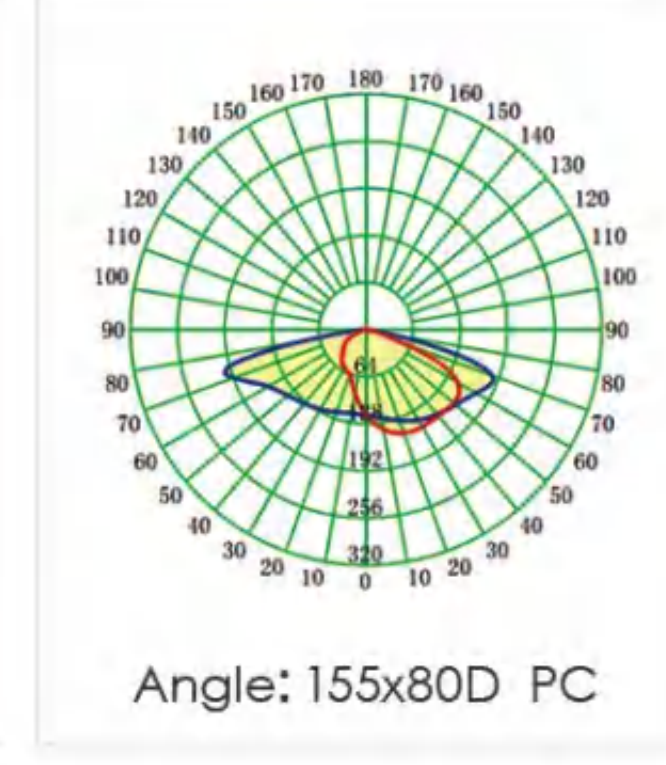

HZ-5050-10H1-T2M-Cutoff-5050

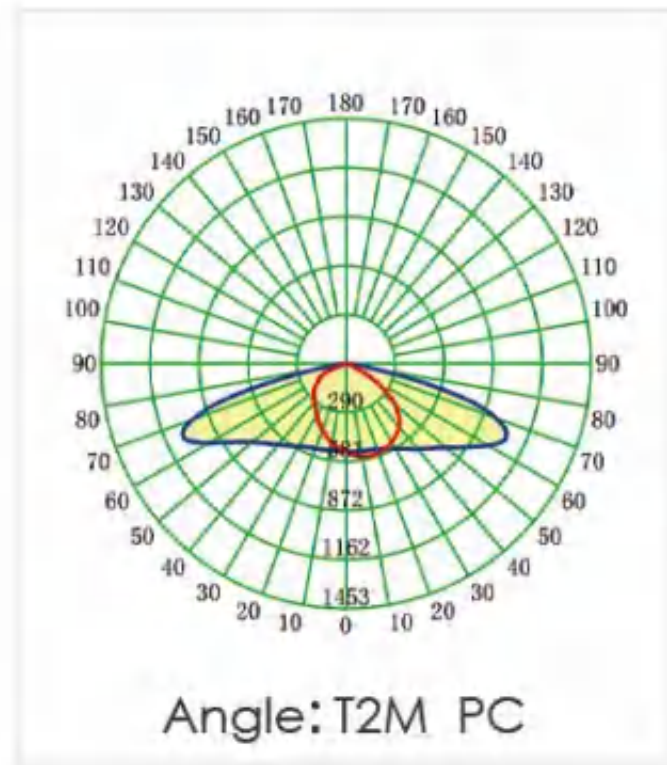

HZ-5050-12H1-T4M-3030

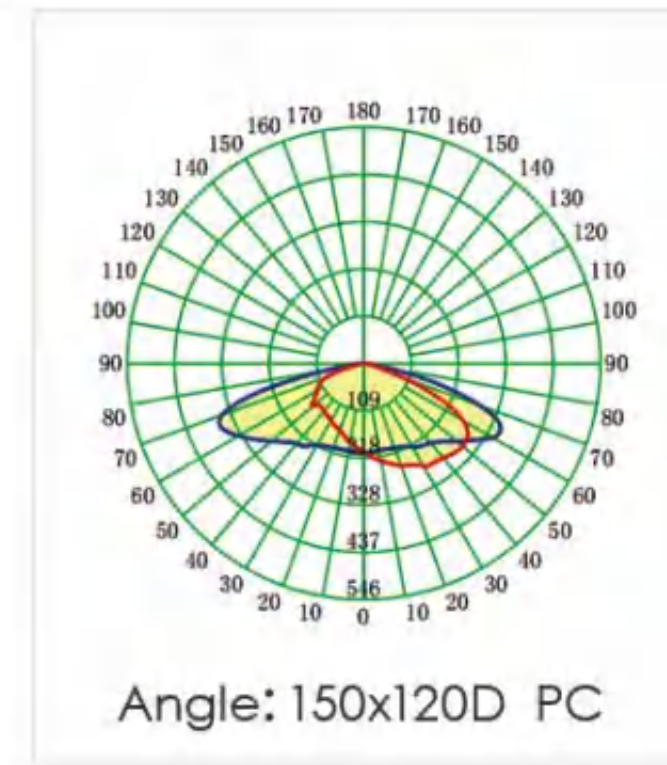

HZ-5050-12H1-T5M-3030

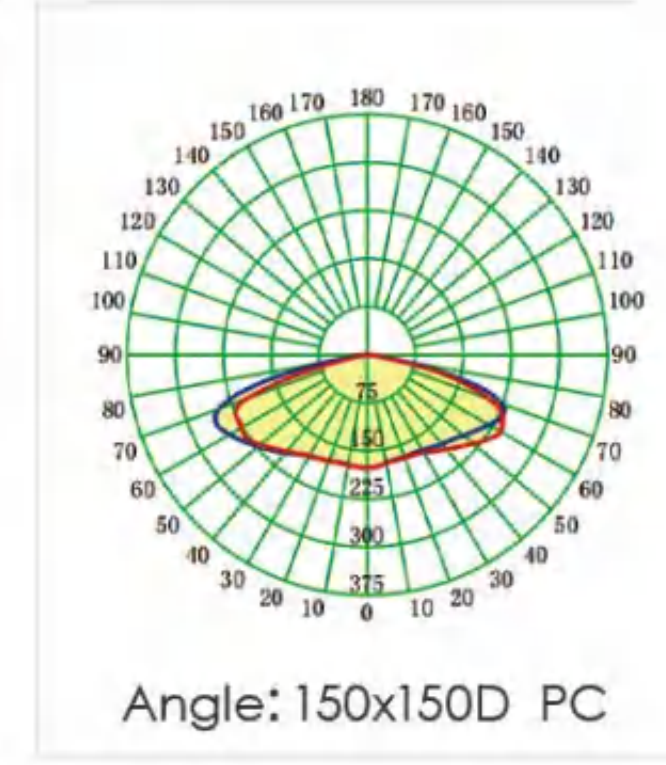

HZ-5050-12H1-20/40D-2835/3030

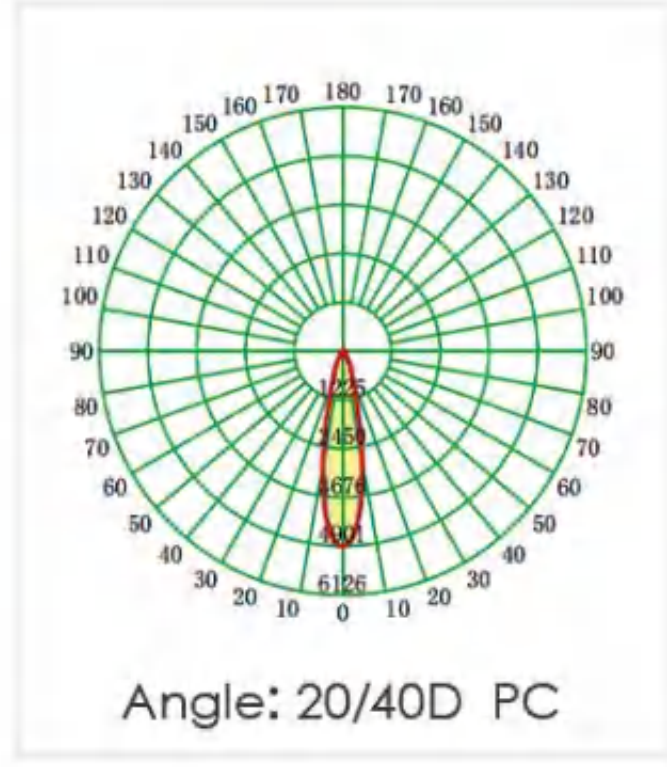

HZ-5050-12H1-60/90D-3030/5050

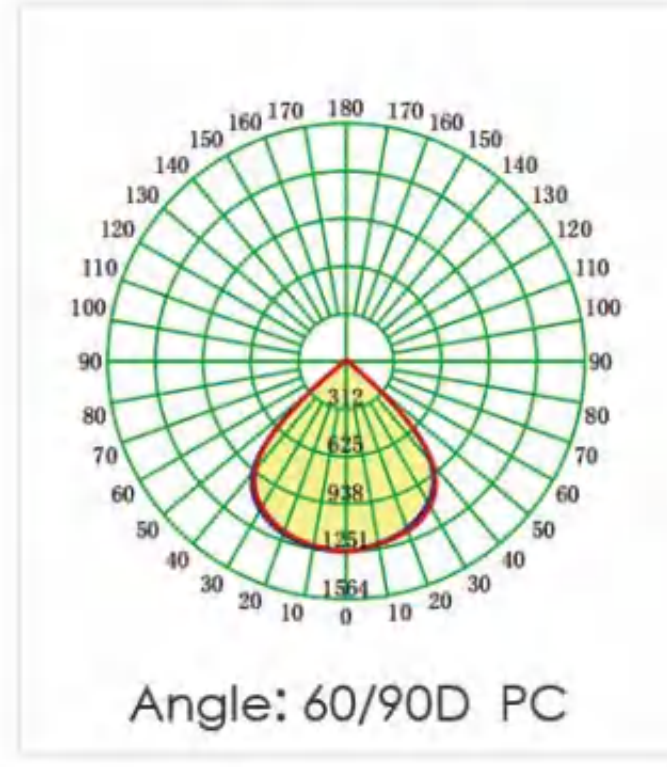

HZ-5050-16H1-15/20/25D-3030

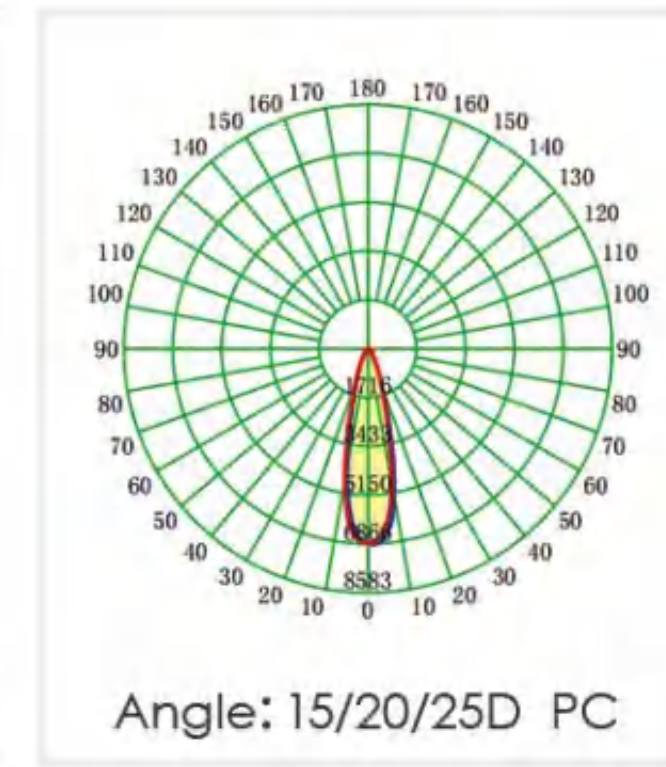

HZ-5050-12H1-60x90/90x120D-3030

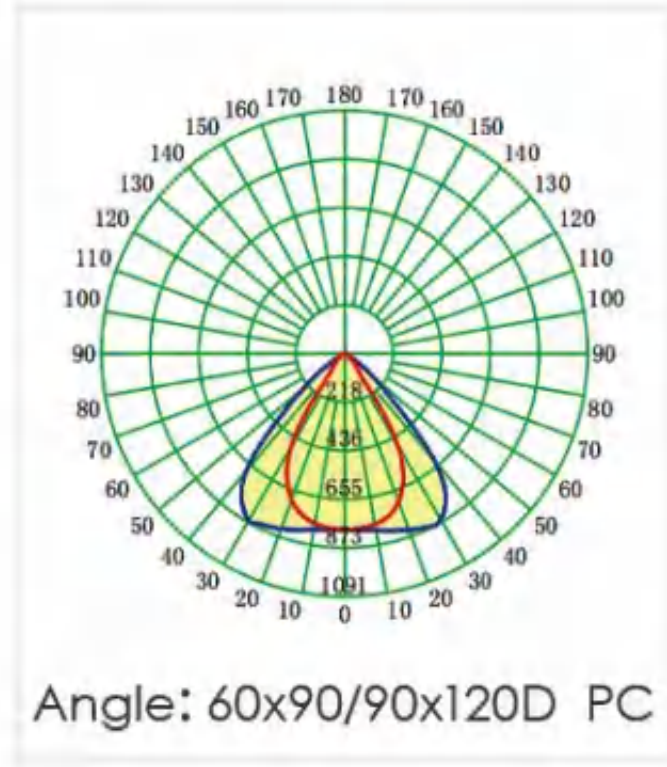

HZ-5050-12H1-TIIM-5050

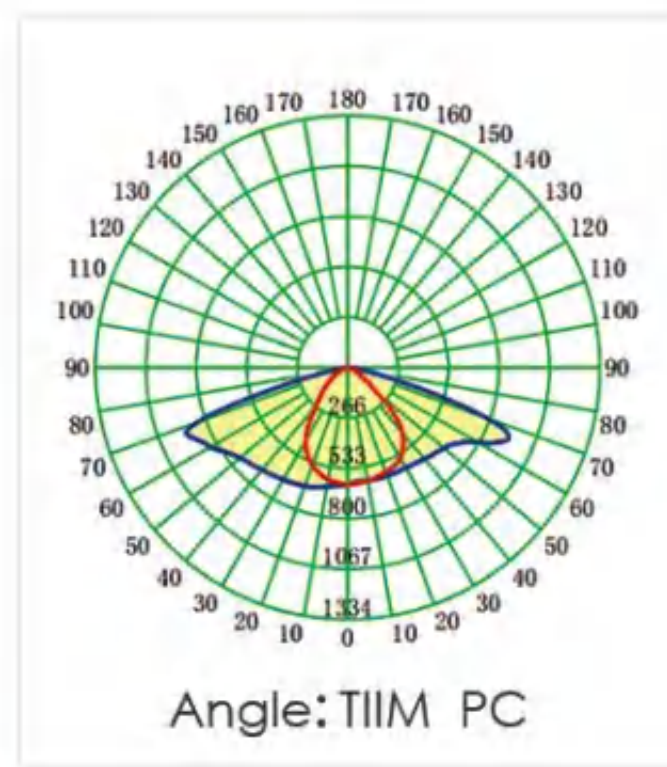

HZ-5050-16H1-40D-3030

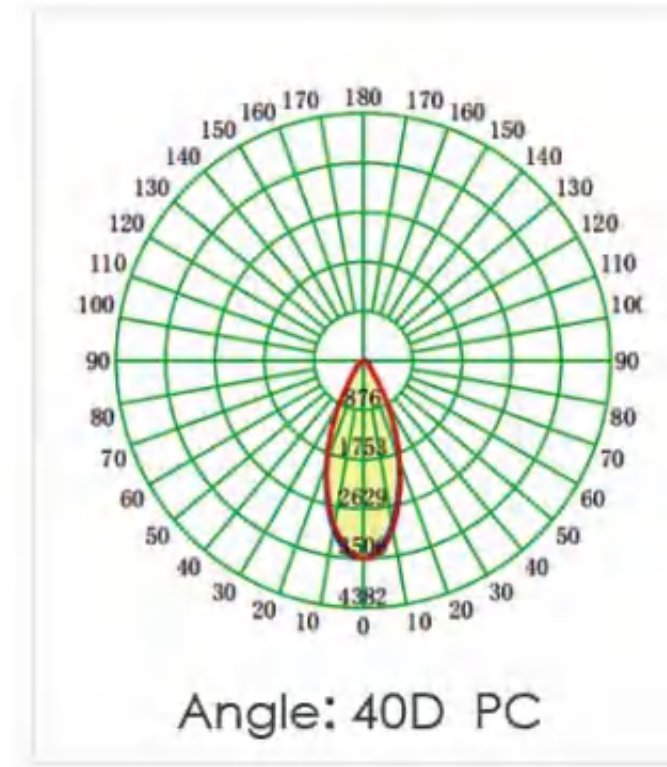

HZ-5050-16H1-30/60/90D-3030

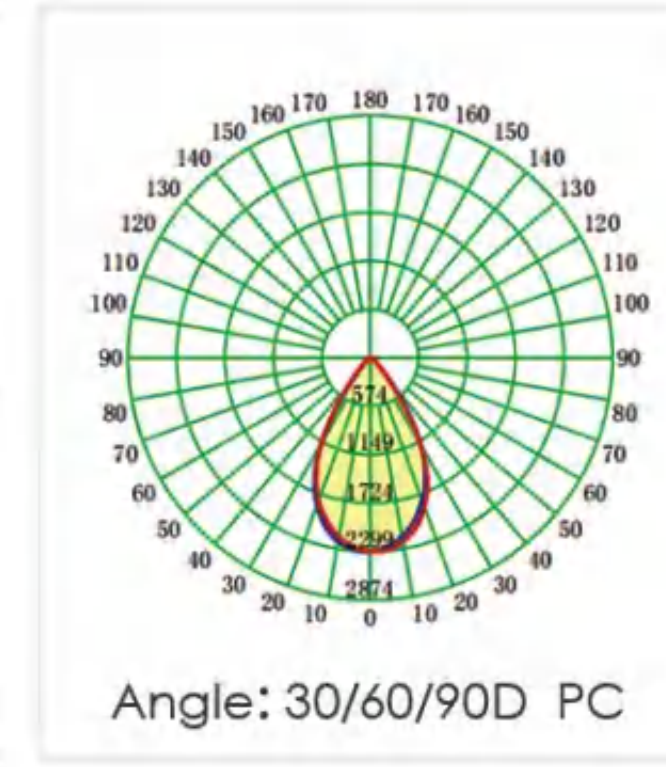

HZ-5050-16H1-60x90/90x120D-3030

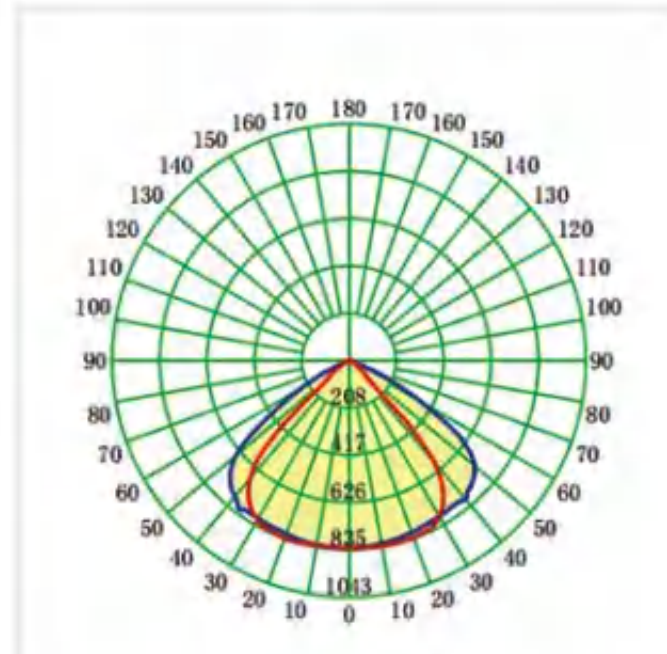

Angle: 60x90/90x120D PC

HZ-5050-16H1-120D-3030

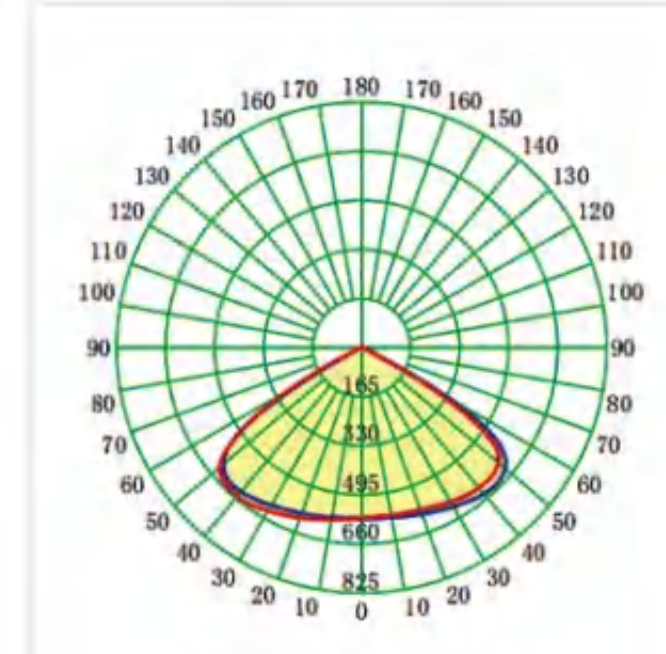

Angle: 120D PC

HZ-5050-16H1-TIIM-3030

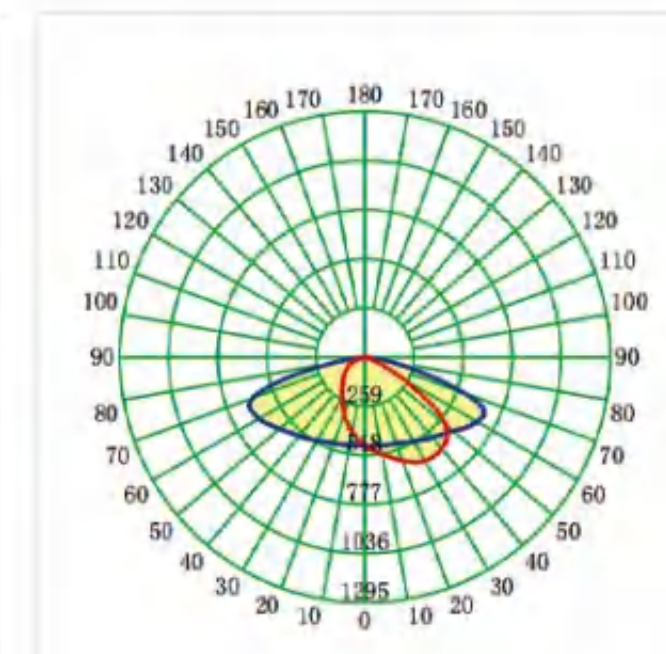

Angle: 157x75D PC/PMMA

HZ-5050-16H1-T4M-3030

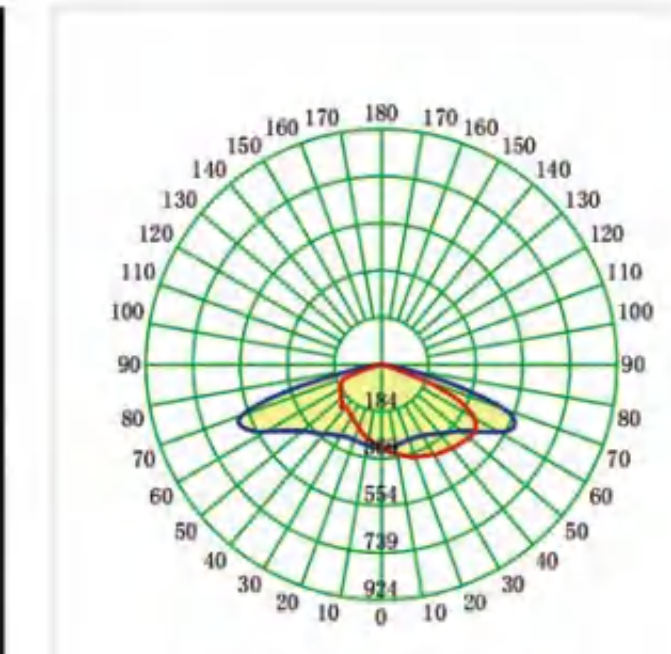

Angle: 150x110D PC

HZ-5050-16H1-P30-3030

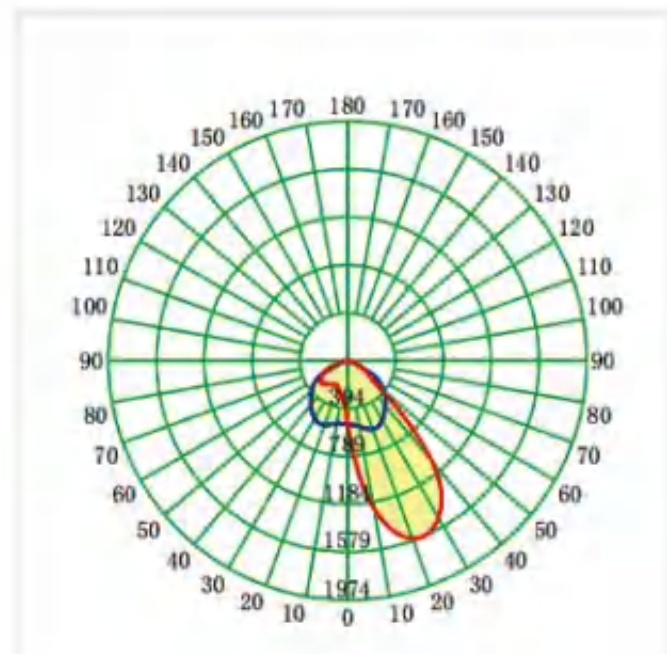

Angle: P30D PC

HZ-5050-16H1-P40-3030

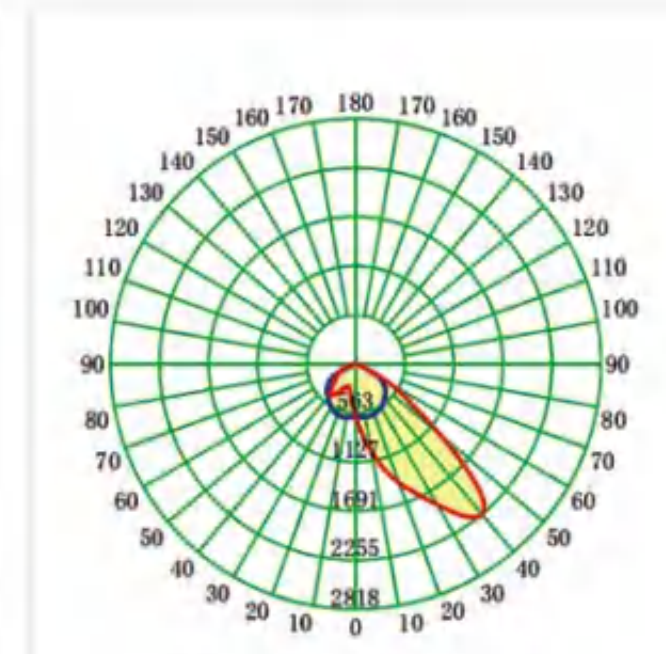

Angle: P40D PC

HZ-5050-16H1-T5-3030

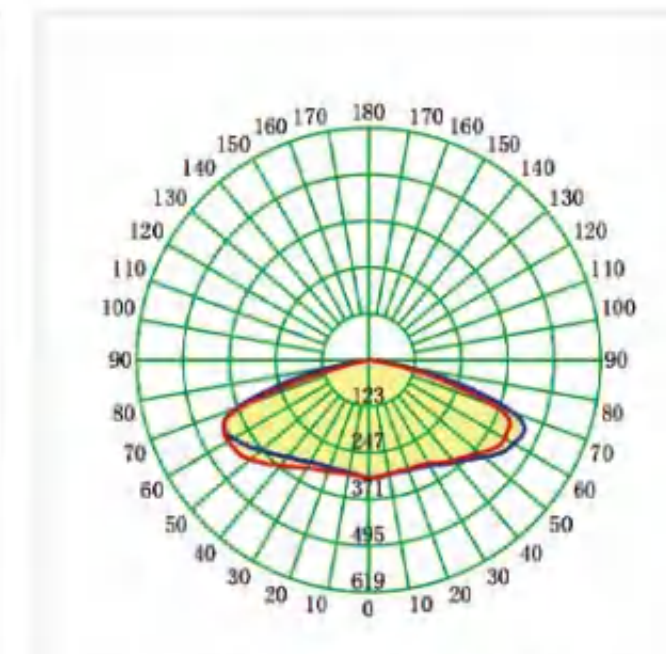

Angle: 150x145D PC

HZ-5050-16H1-T5-3535

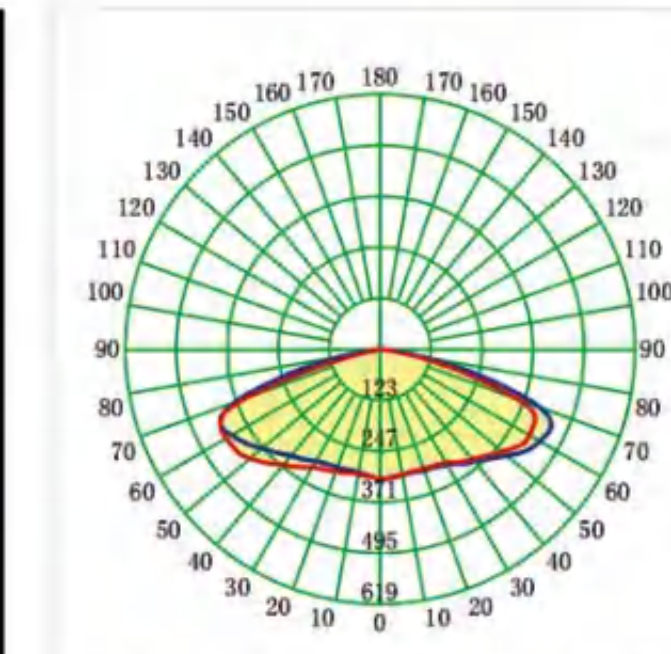
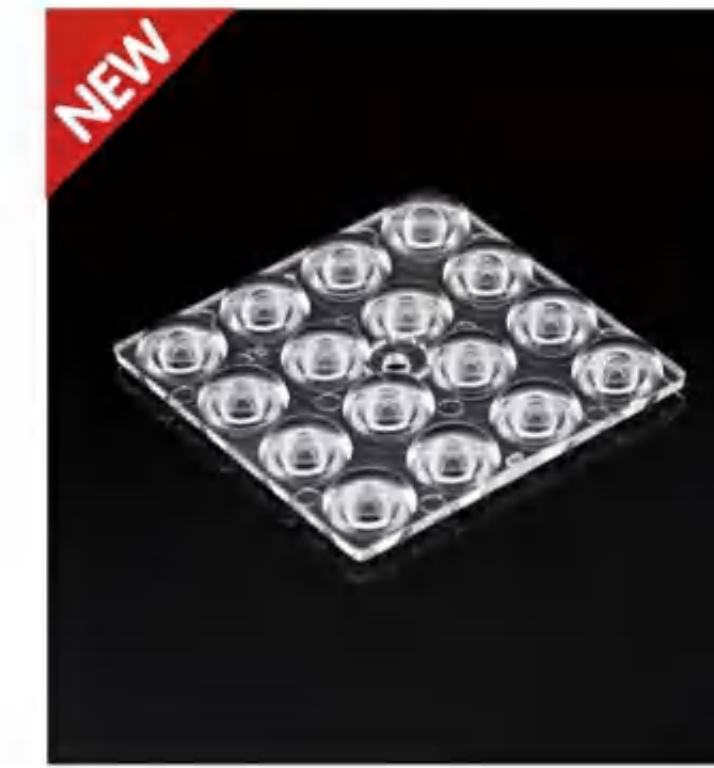

Angle: 150x145D PMMA

HZ-5050-16H1-TIM-3030

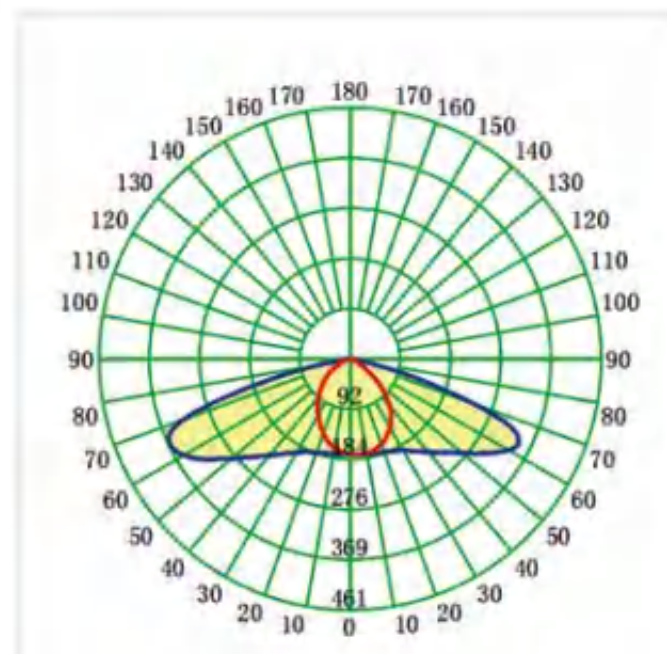

Angle: 155x70D PC

HZ-5050-16H1-TIIM-3030

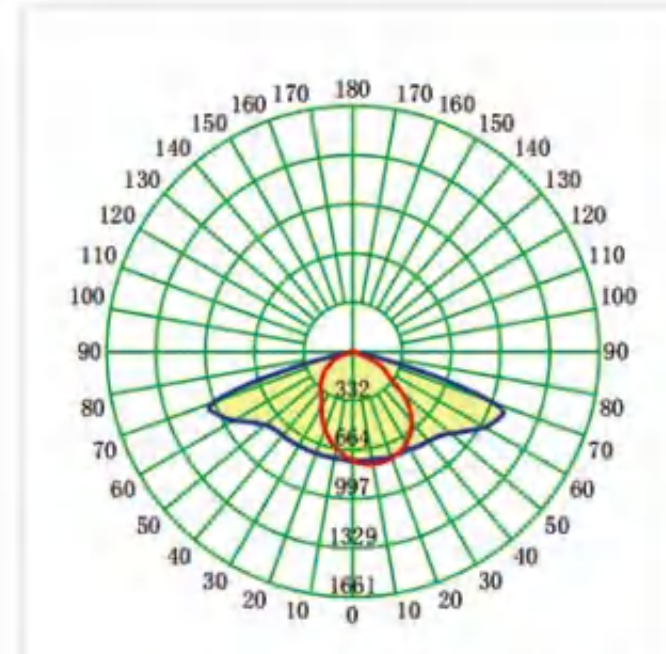

Angle: TIIM PC/PMMA

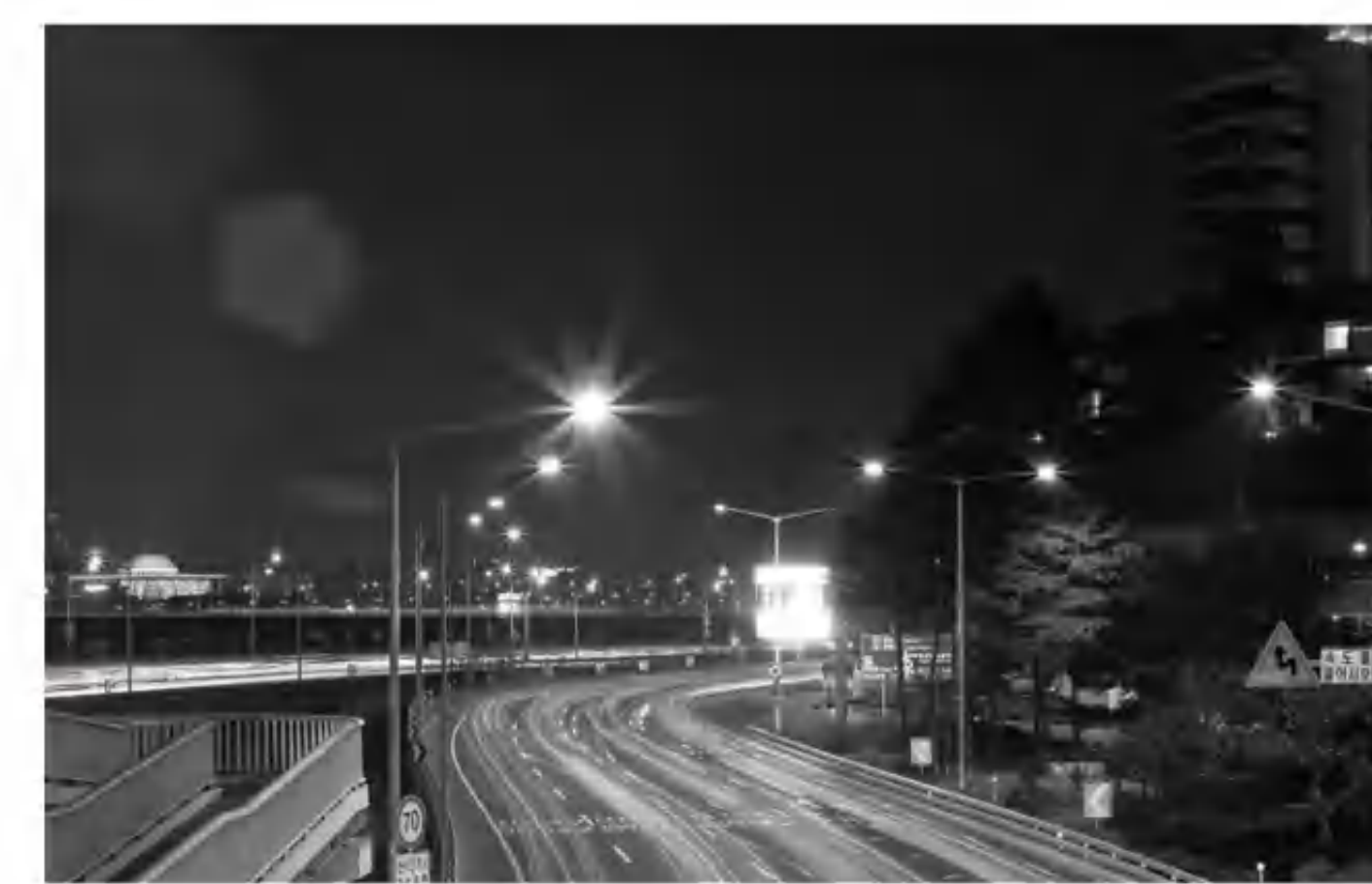

HZ-5050-24H1-15D-3030

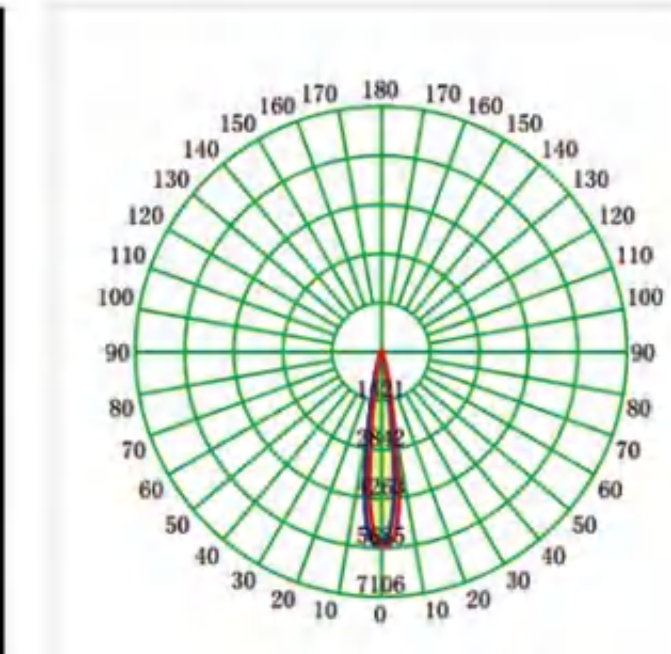

Angle: 15D PC

HZ-5050-16H1-TIIM-cutoff-3030

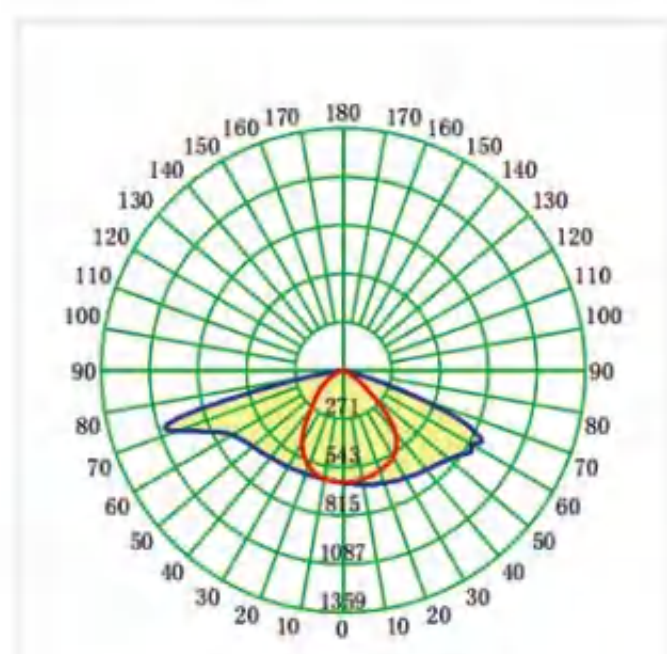

Angle: 145x85D PC

HZ-5050-16H1-TPIIM-Semi-Cutoff-3030

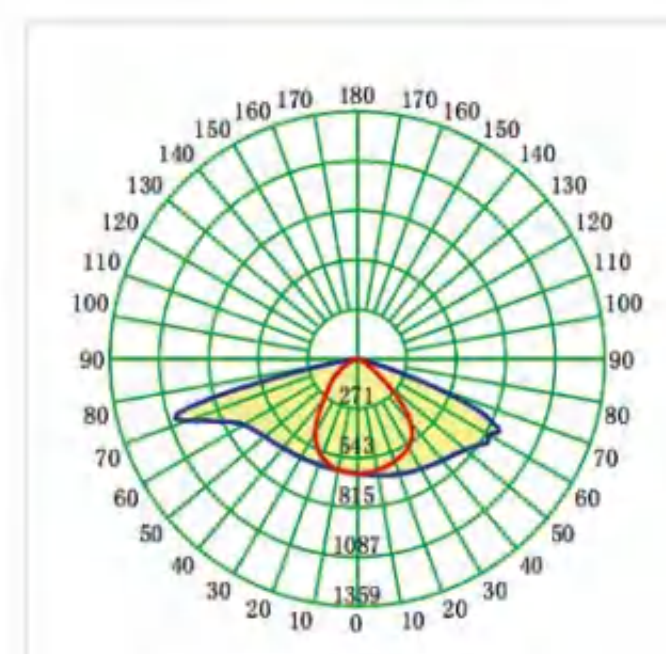

Angle: 150x70D PC

HZ-5050-24H1-25D-3030

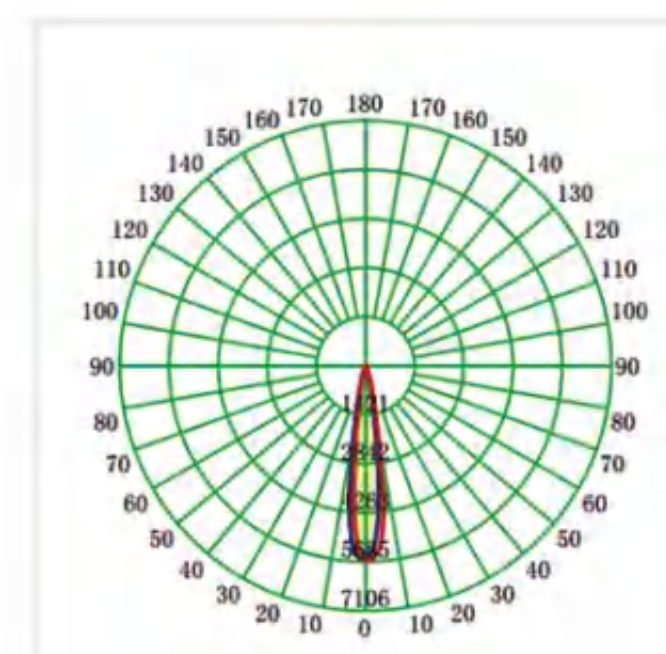

Angle: 25D PC

HZ-5050-24H1-30/60D-3030

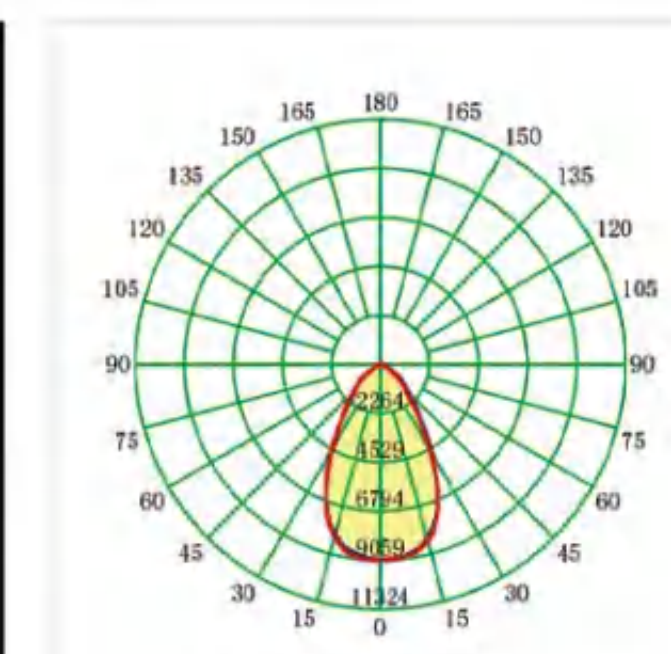

Angle: 30/60D PC

HZ-5050-24H1-90/120D-3030

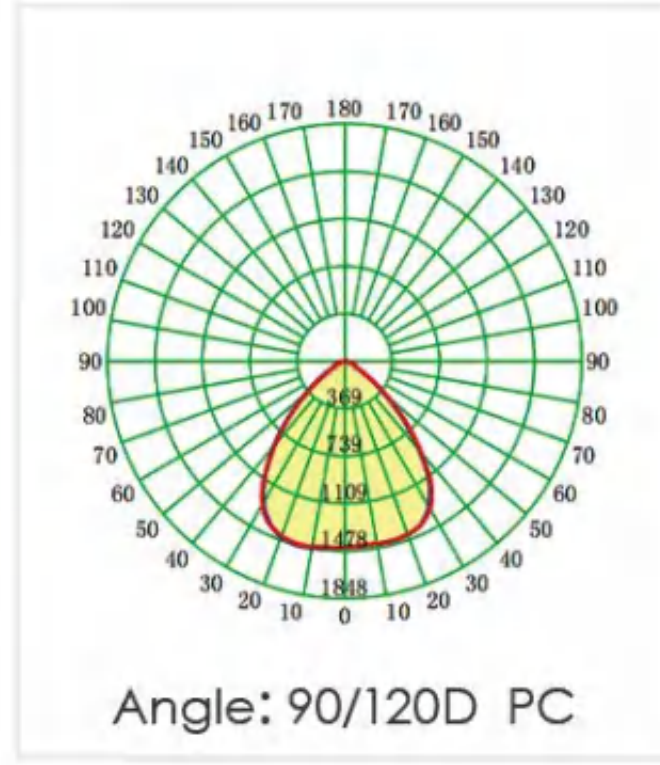

HZ-5050-24H1-P35D-3030

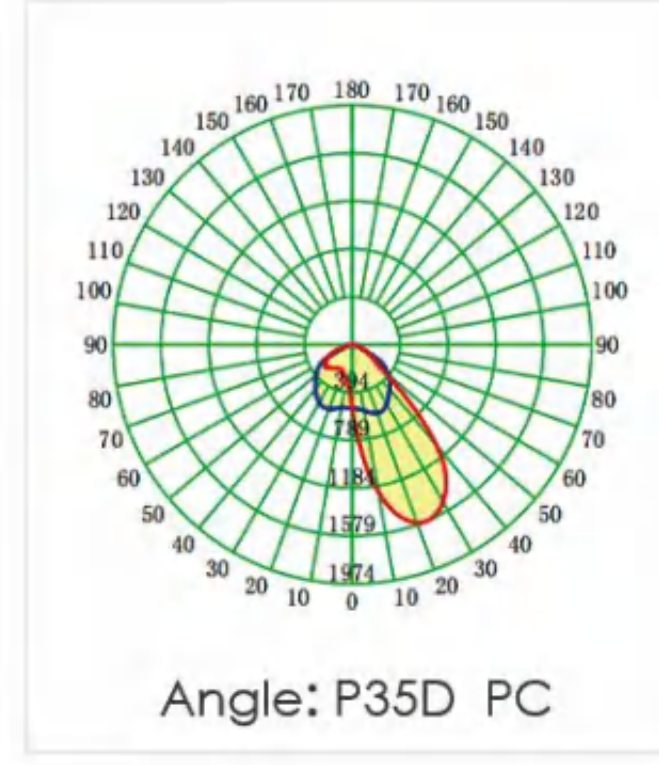
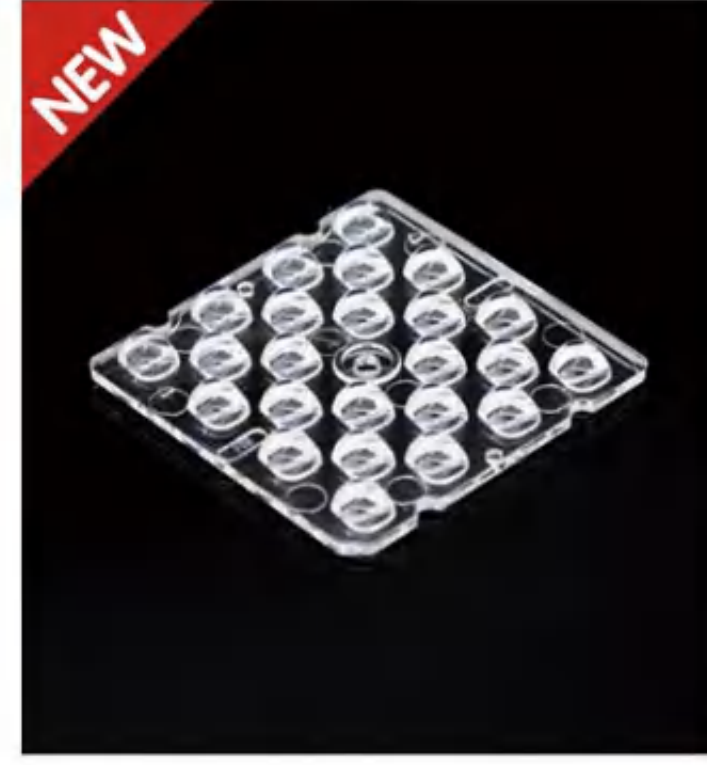

HZ-5050-24H1-ME1/ME3-3030

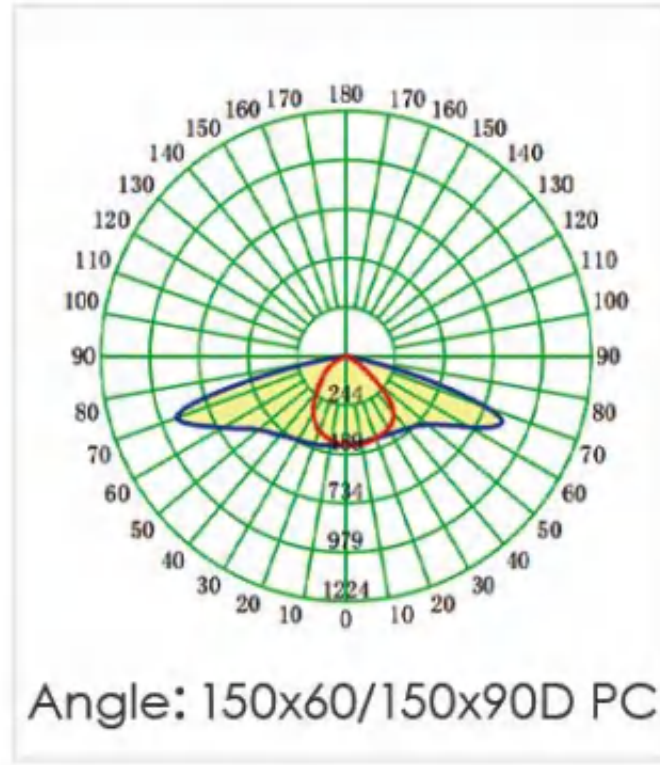

HZ-5050-24H1-ME4/ME5-3030

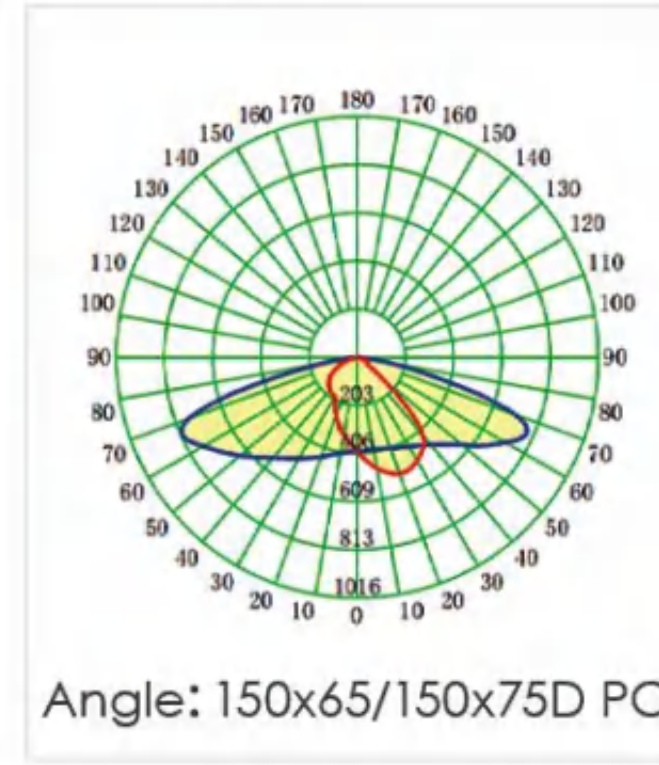

HZ-5050-24H1-T2M-3030

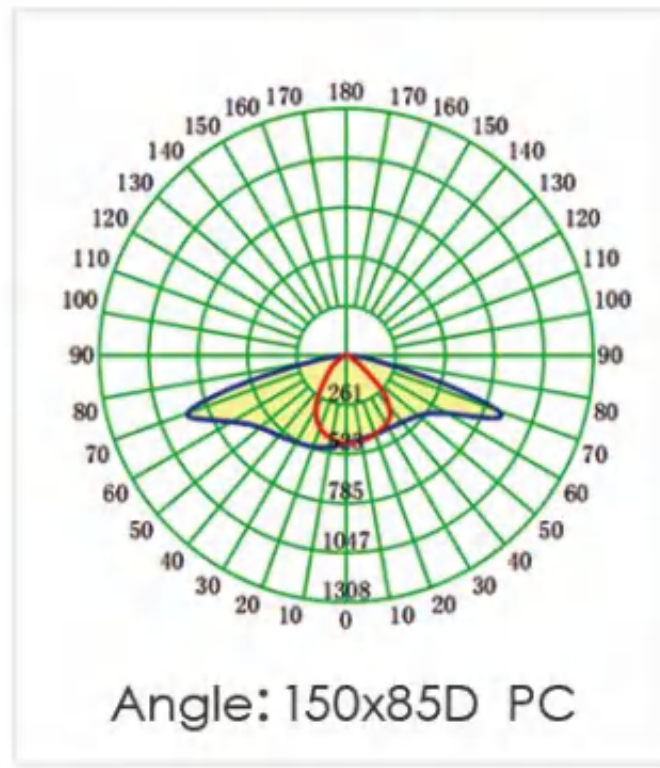

HZ-5050-24H1-T3M-3030

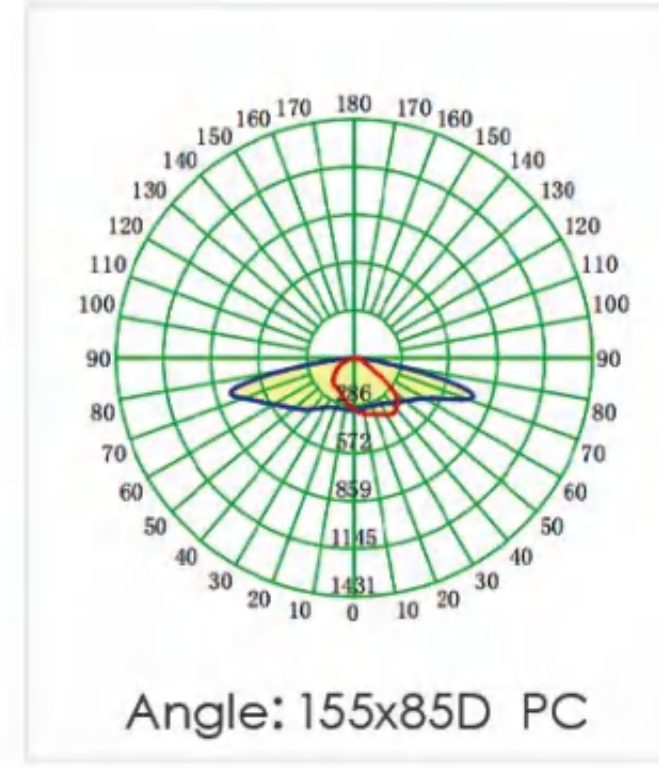

HZ-5050-24H1-T4-3030

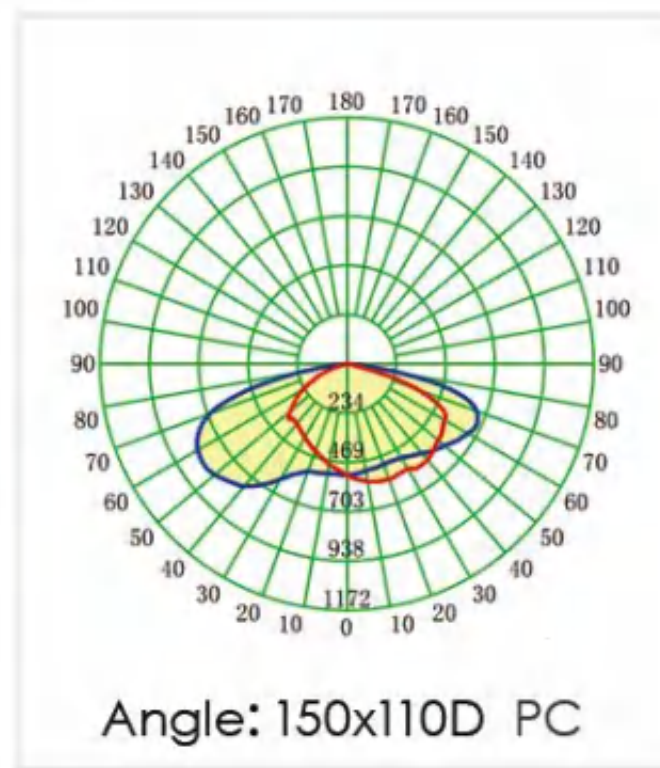

HZ-5050-24H1-T5-3030

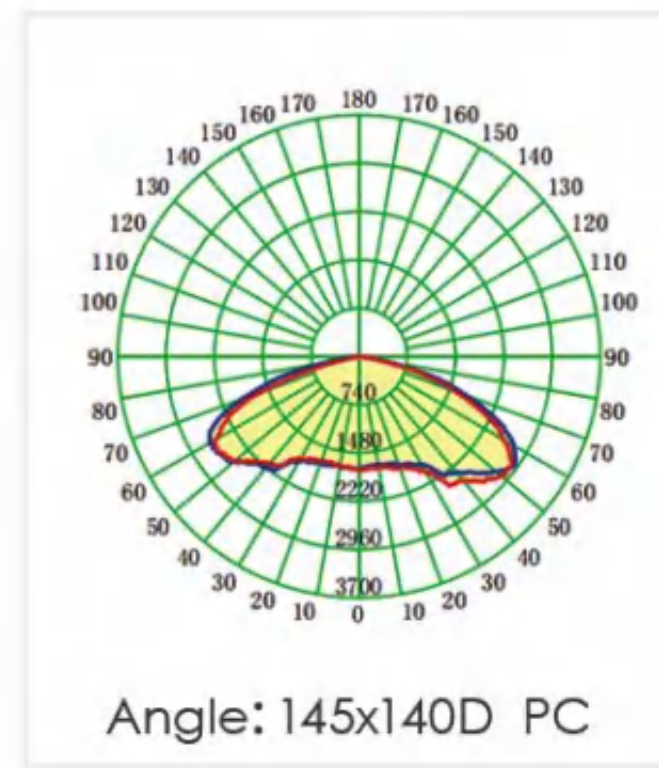

9090 LED optik lensler 9090 led optical lens



Applicable light source / Işık kaynağı uygulama



2835

3030

3535

5050

7070

HZ-9090-4H1-65D-7070

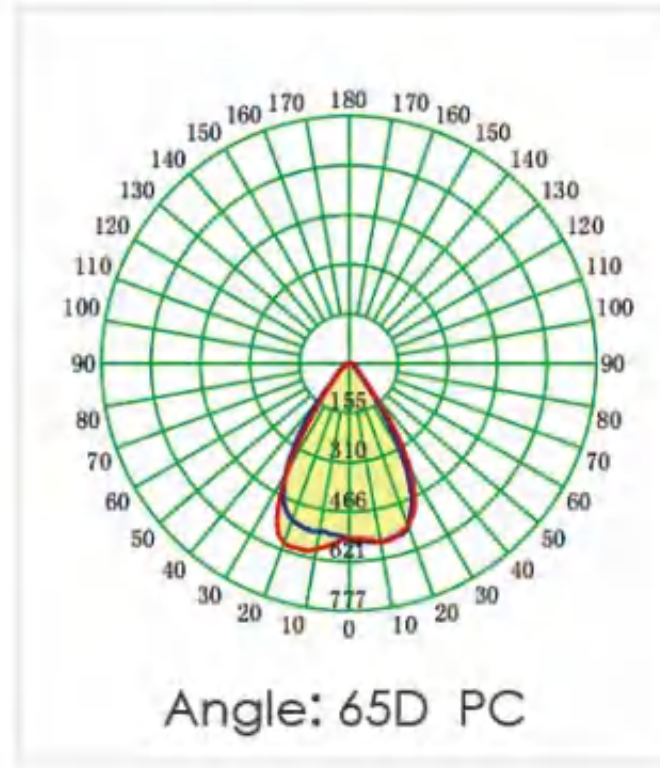

HZ-9090-4H1-T2-7070

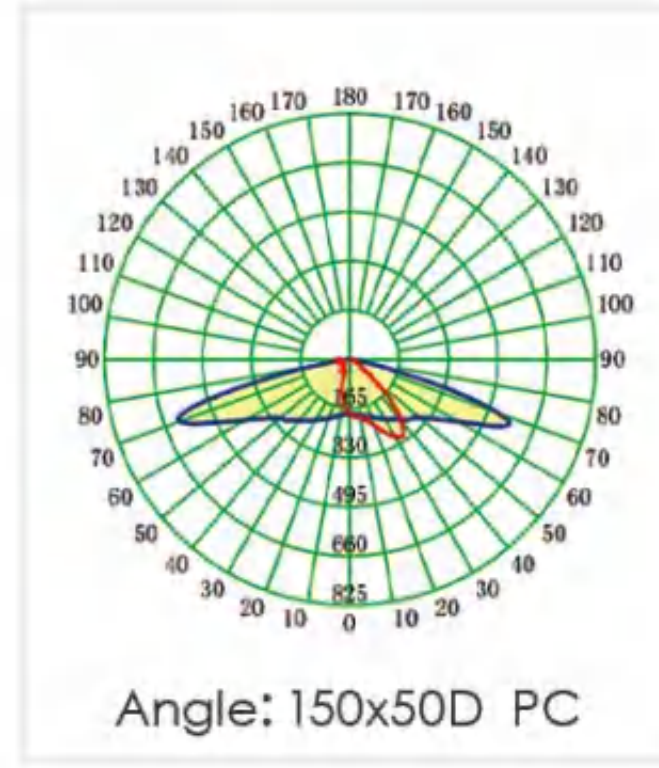

HZ-100x100-28H1-T2M-2835/3030

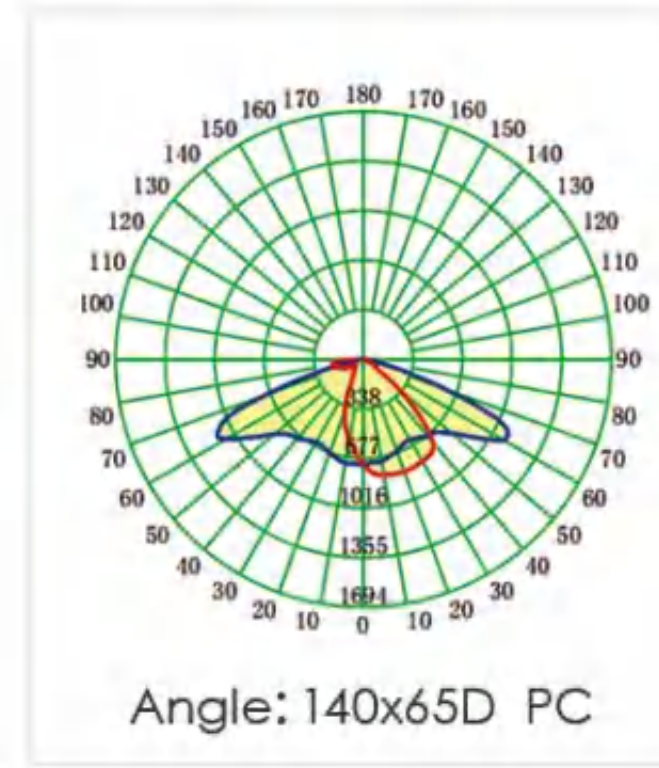

HZ-9090-8H1-60/90D-5050

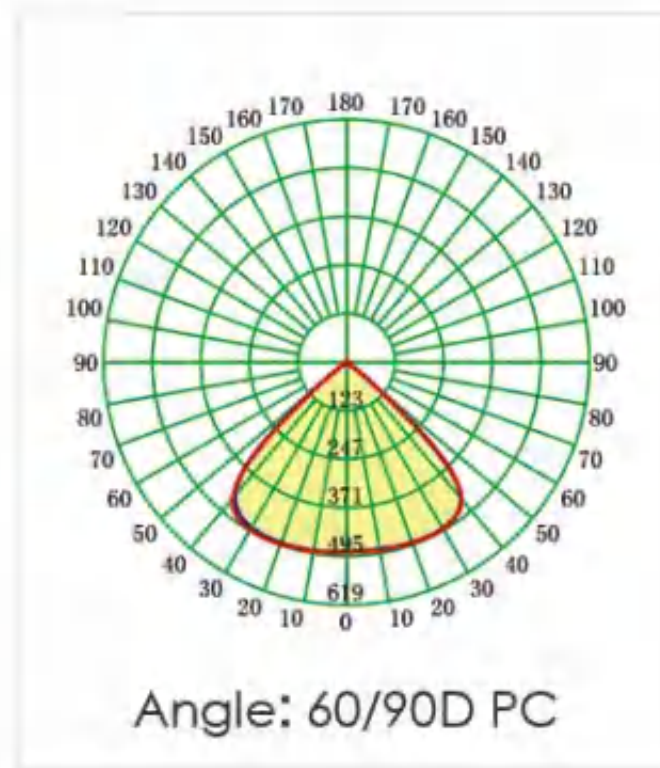

HZ-9090-8H1-T2M-5050

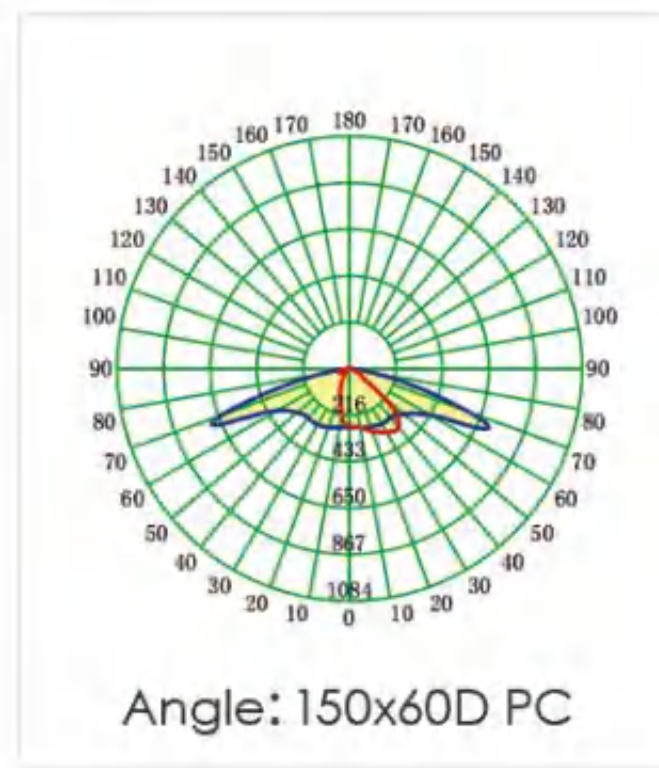

HZ-100x60-16H1-60D-3535

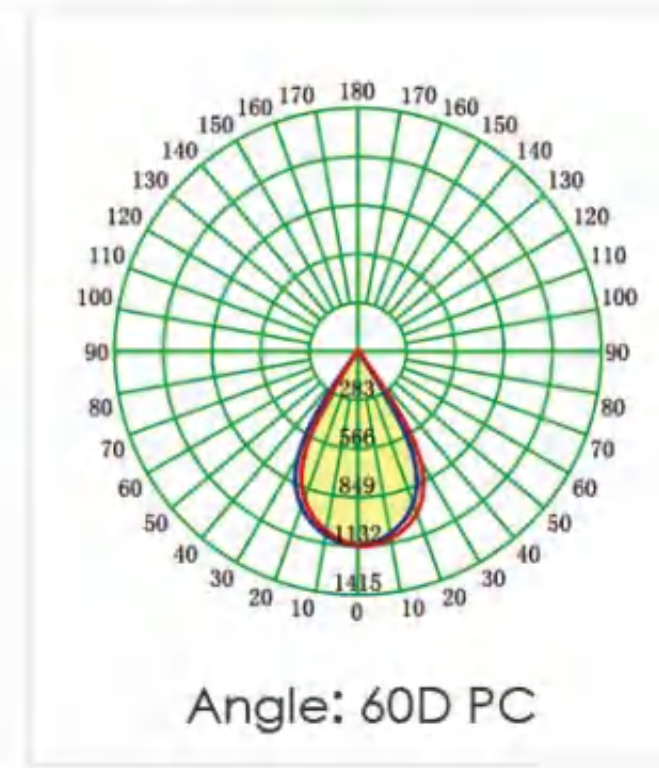

HZ-100x60-16H1-T2M-3535

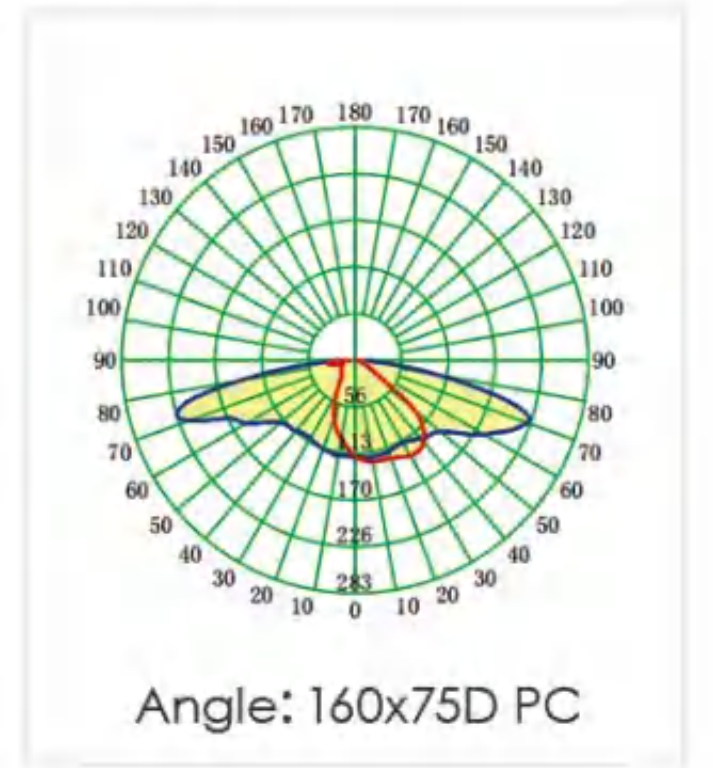

HZ-9090-8H1-T3M-5050

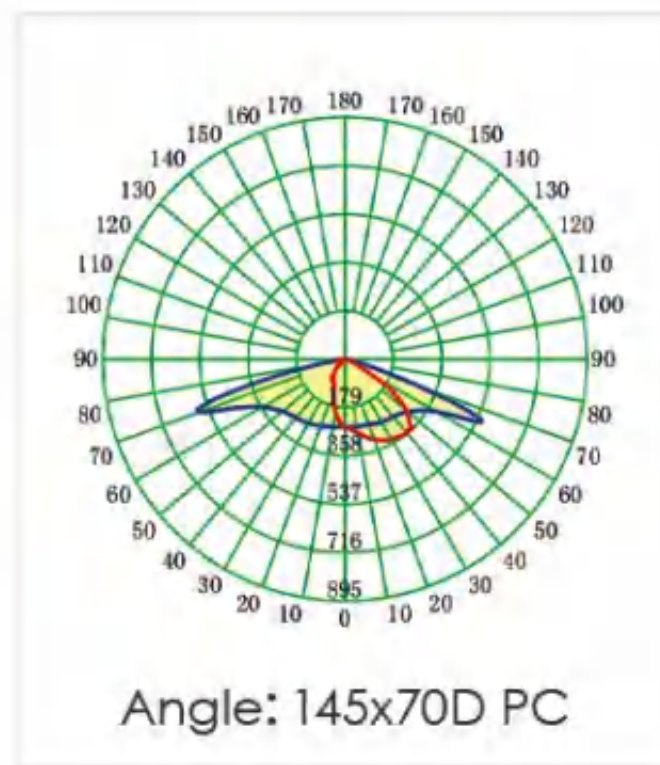

HZ-9090-16H1-60/90D-3535

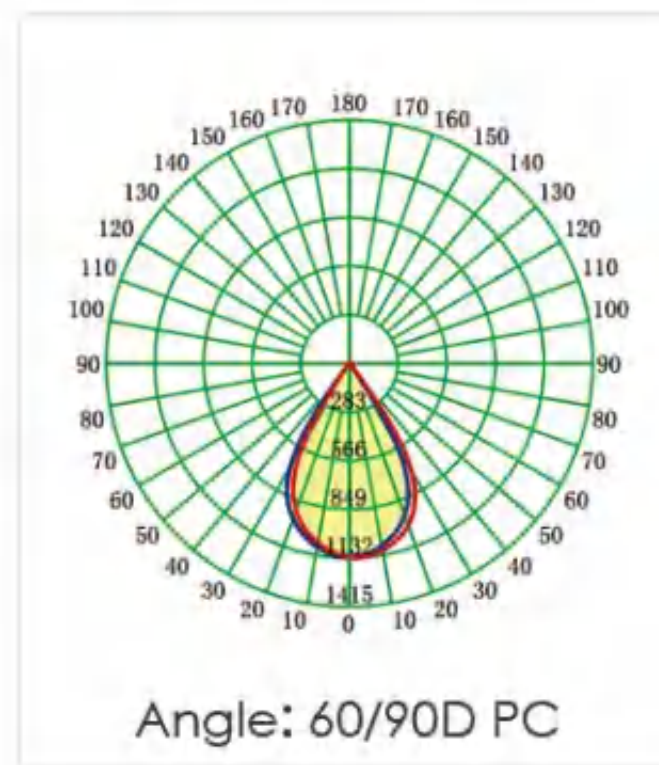

HZ-129x64-12H1-T2-5050

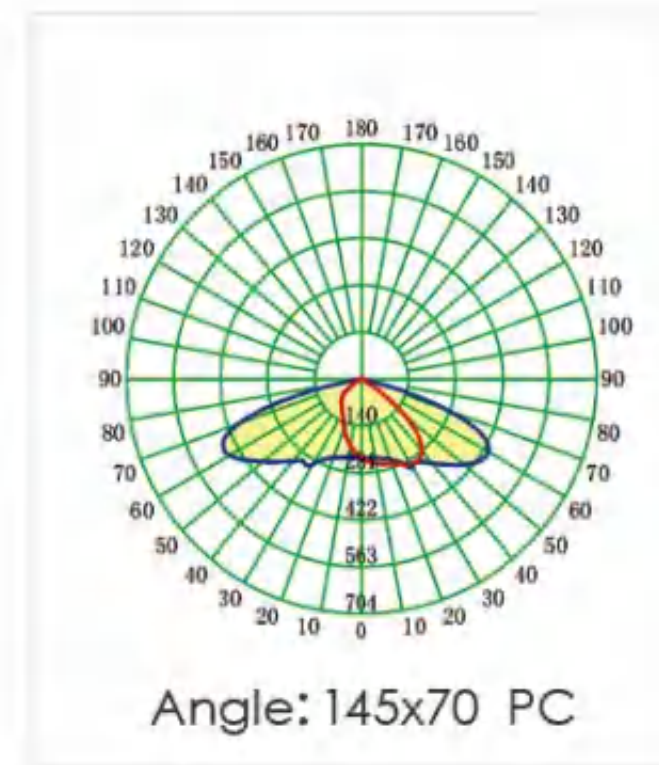

HZ-125x61-12H1-T3-5050

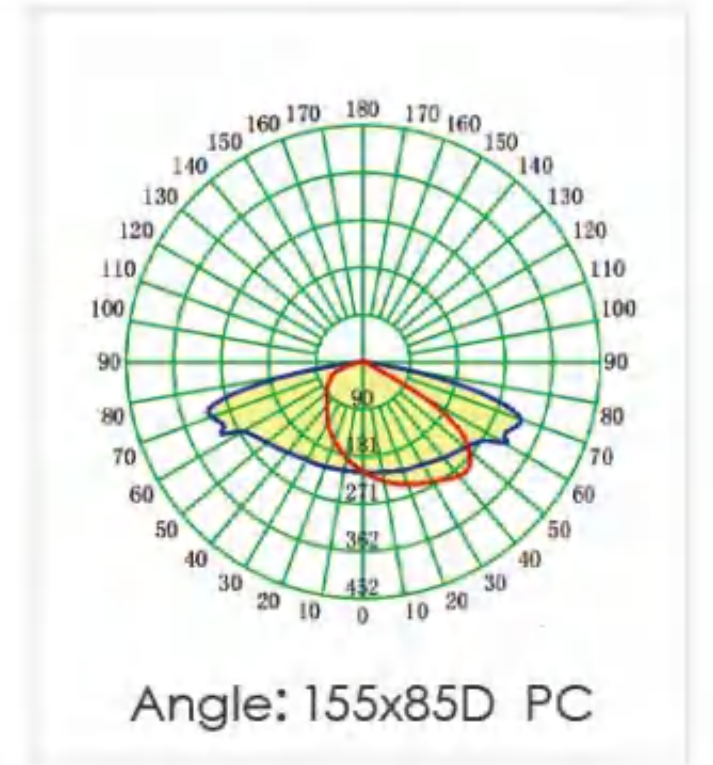

HZ-9090-16H1-T2M-3535

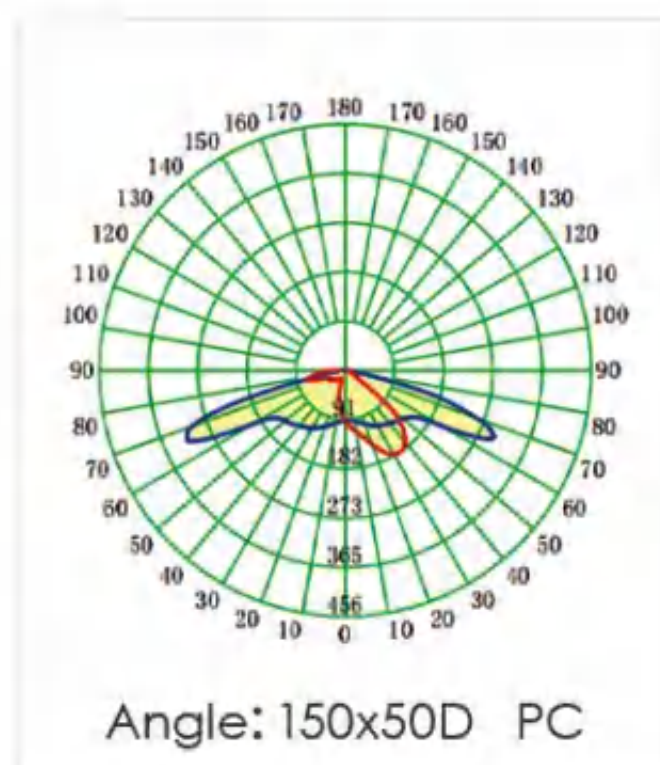

HZ-9090-16H1-T3M-3535

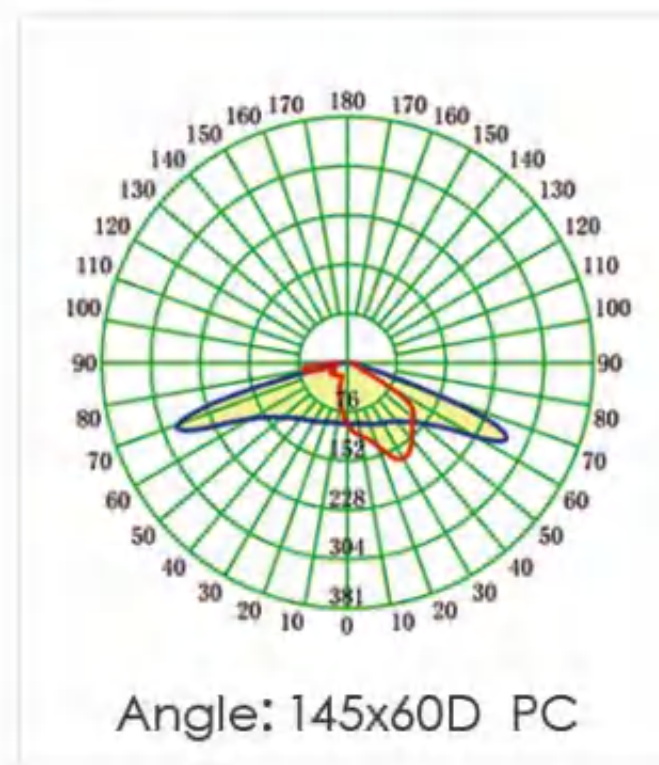

HZ-135X100-24H1-60/90D-3030

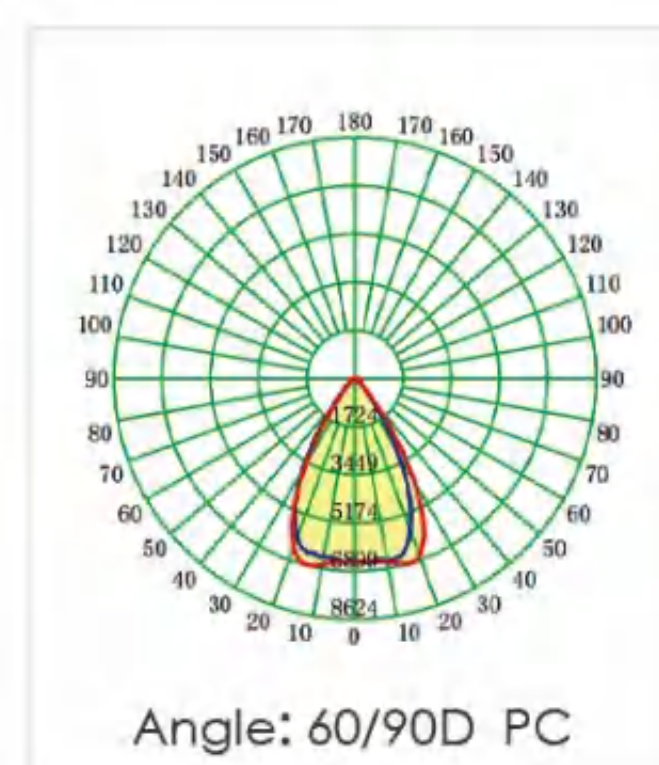

HZ-135X100-24H1-T2M-Cutoff-5050

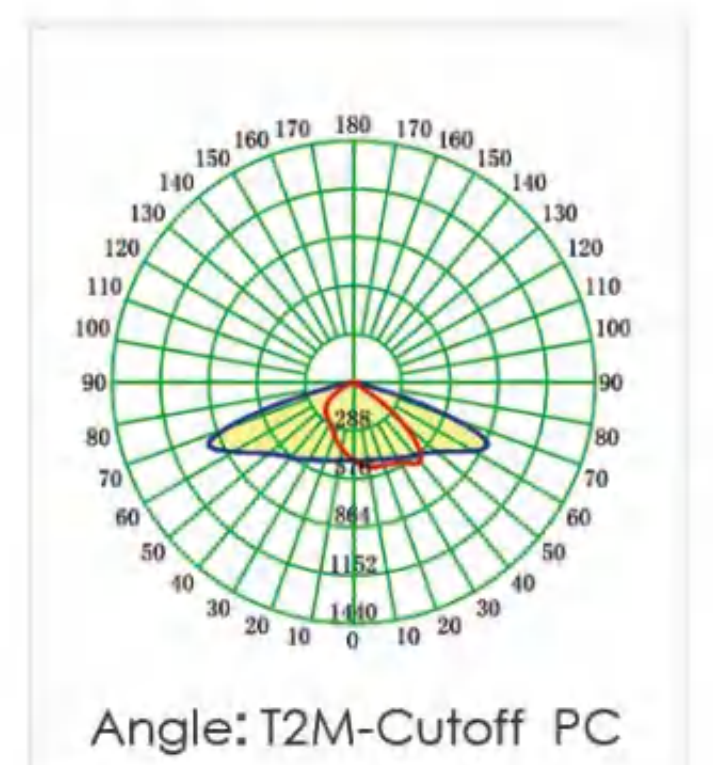



street light
Module lens
SOKAK LAMBASI MODÜLÜ
LENS

.....
Various size optics for your
choice LED Integrated lighting lens for easy installation
Seçiminiz için çeşitli boyutlarda optik cihazlar, LED entegre aydınlatma
lenleri, kolay kurulum

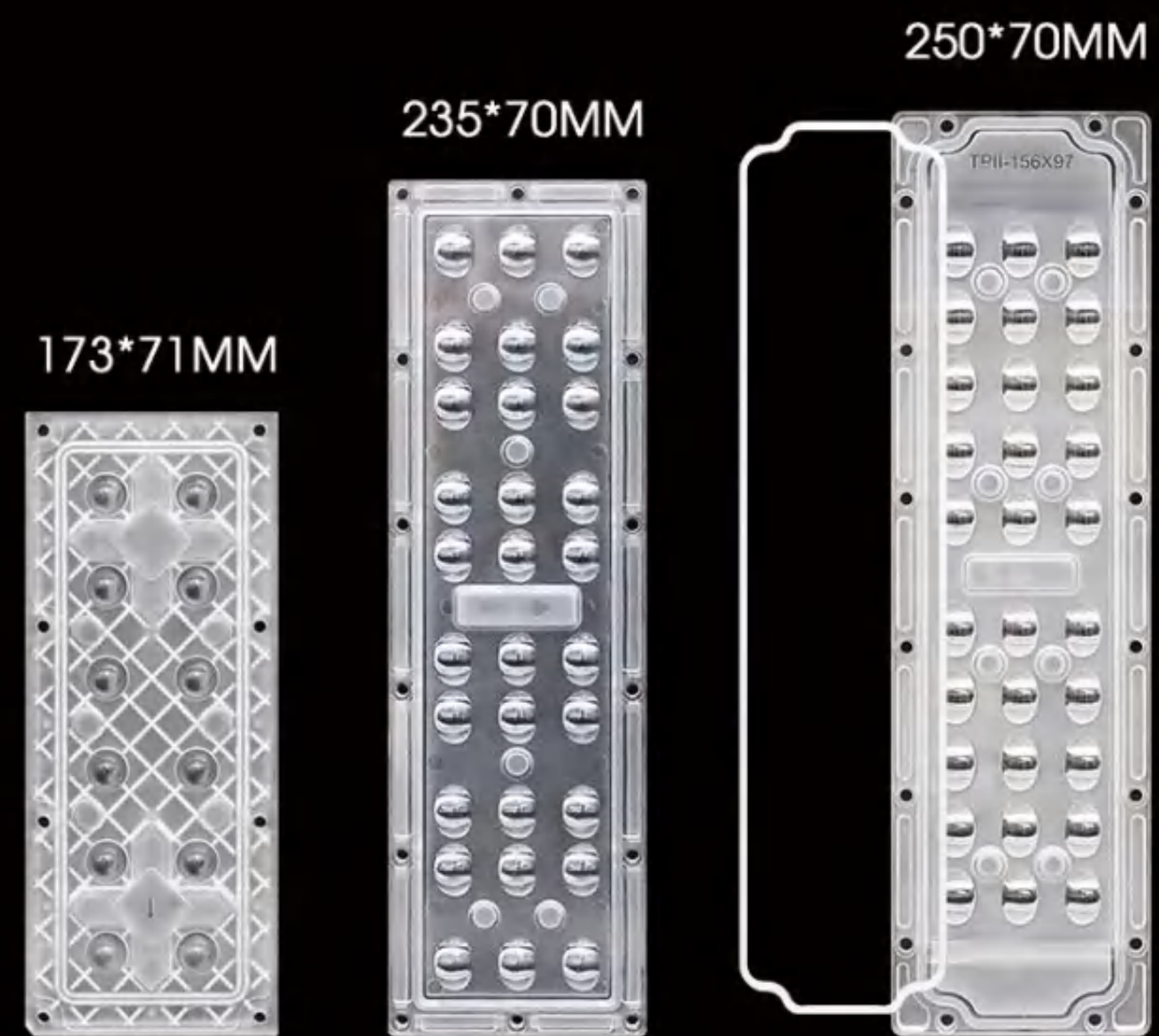

HZ-173x71-12H1-60/90D-5050

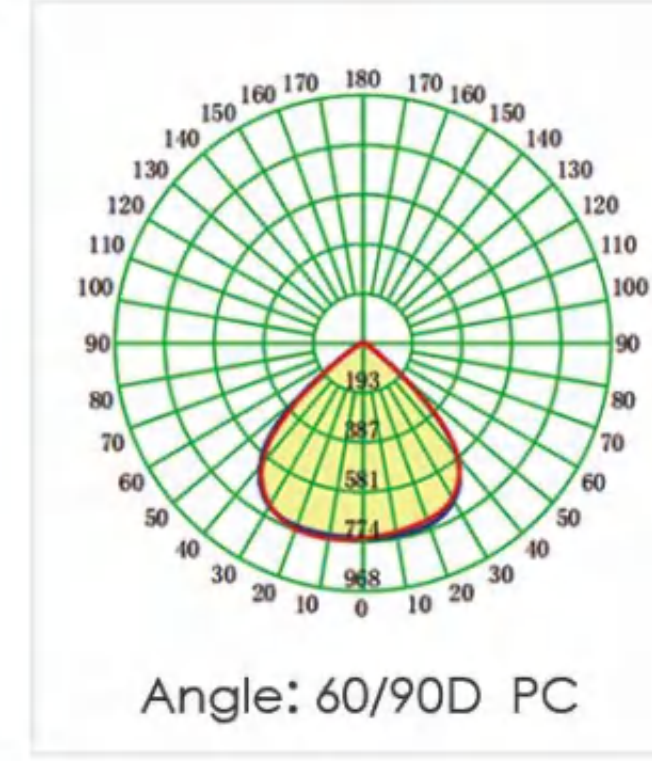

HZ-173x71-12H1-T2M-H-5050

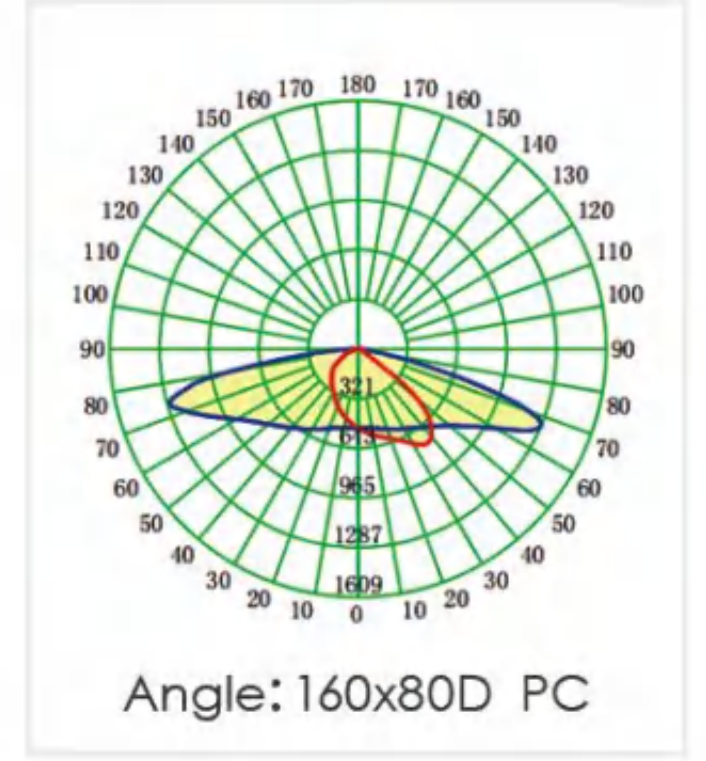

HZ-173x71-12H1-T2M-Cutoff-5050

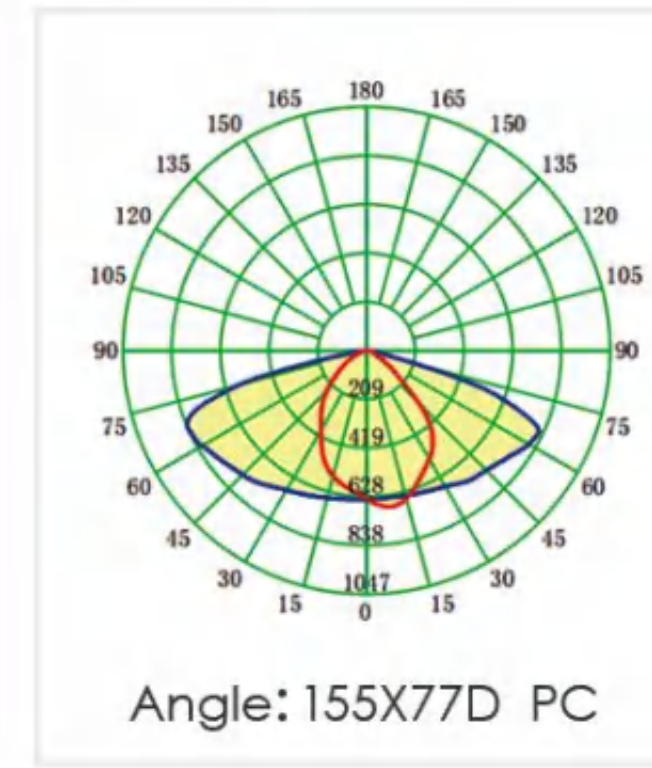

HZ-173x71-12H1-T2M-RE-5050

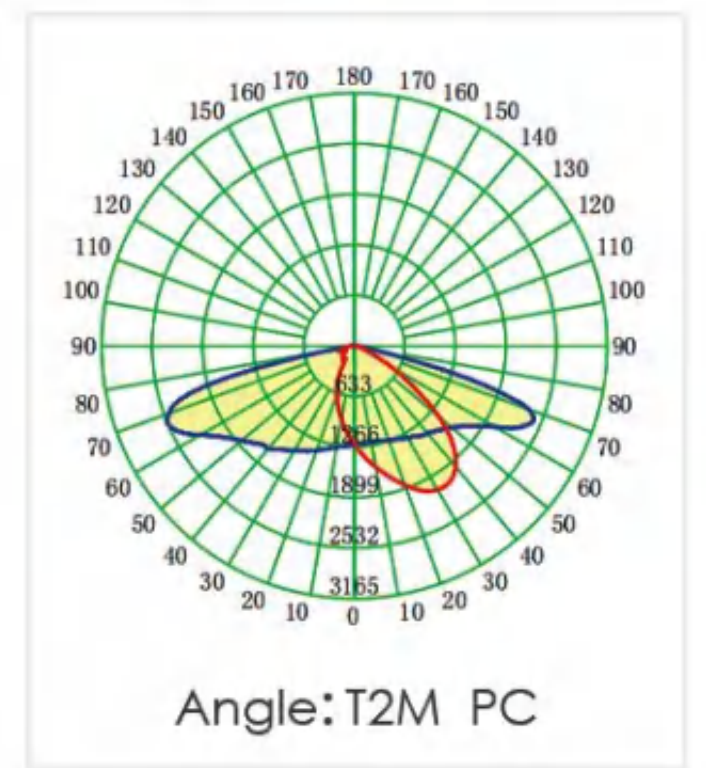

HZ-173x71-12H1-T2M-R-5050

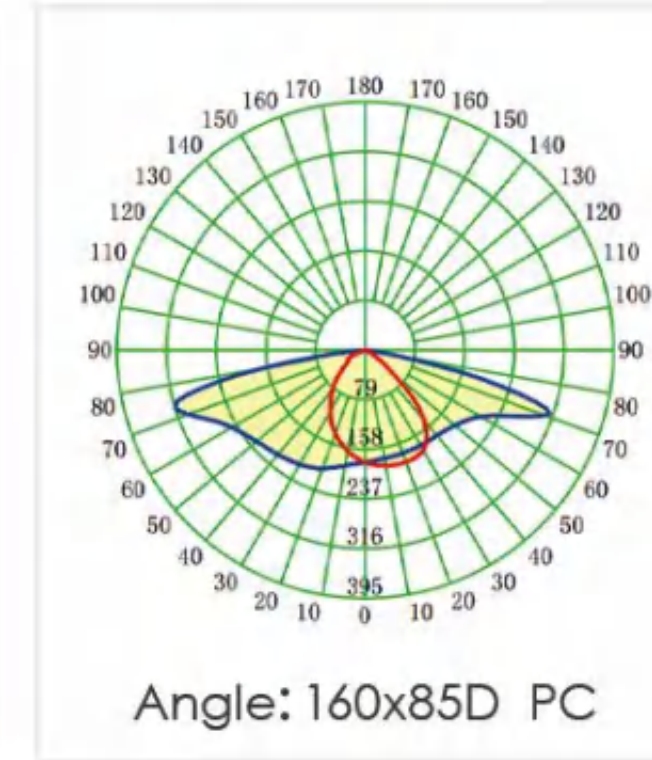

HZ-173x71-12H1-T2M-5050

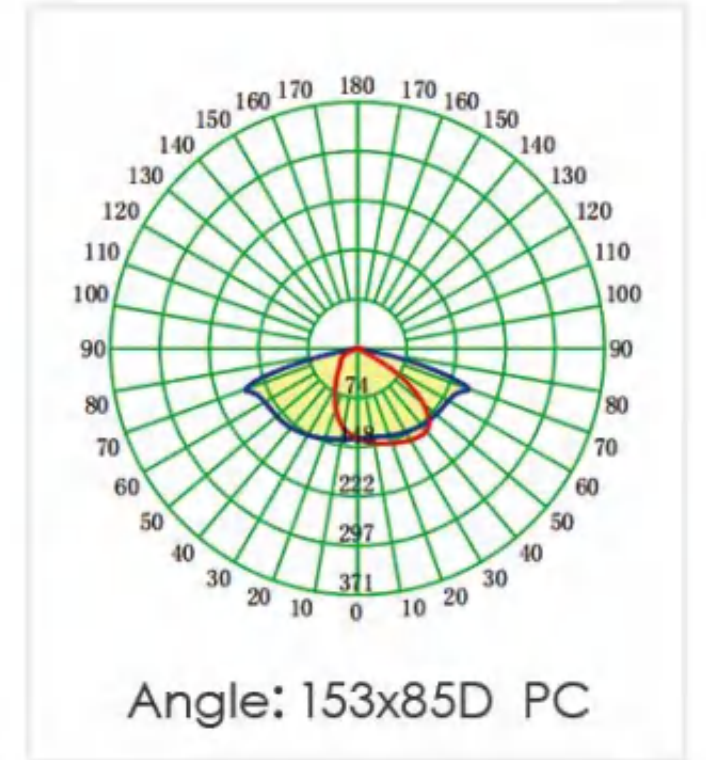

HZ-173x71-12H1-T2M-V-7070

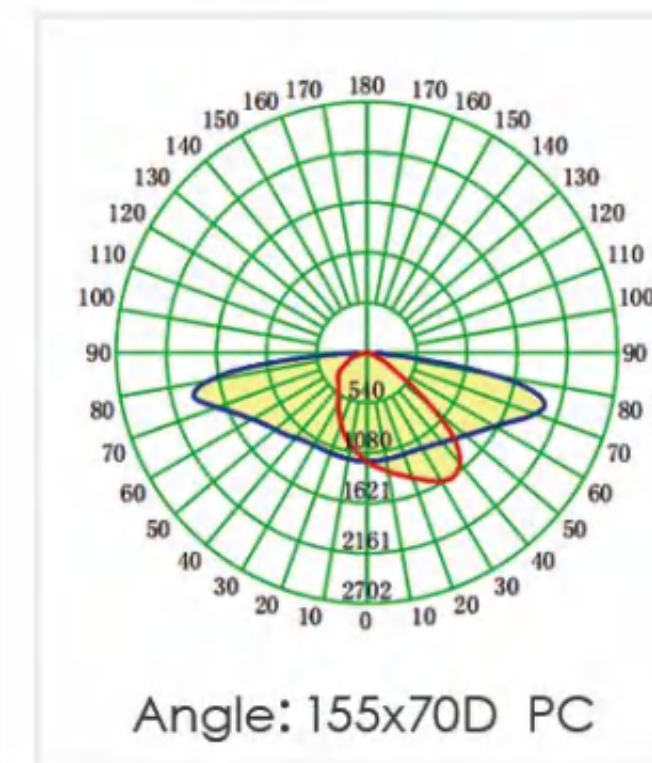

HZ-173x71-12H1-T2M-H-7070

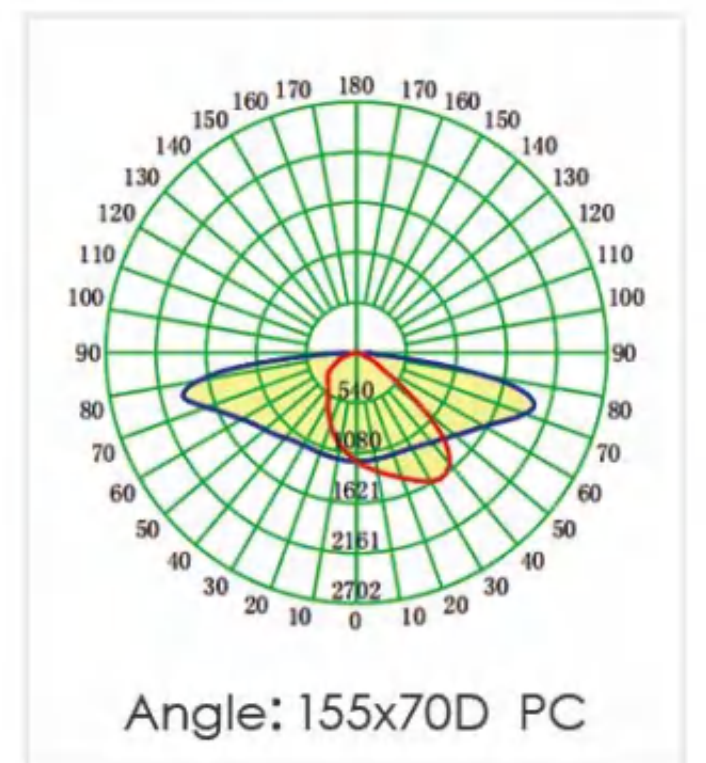

HZ-173x71-24H1-T2M-H-5050

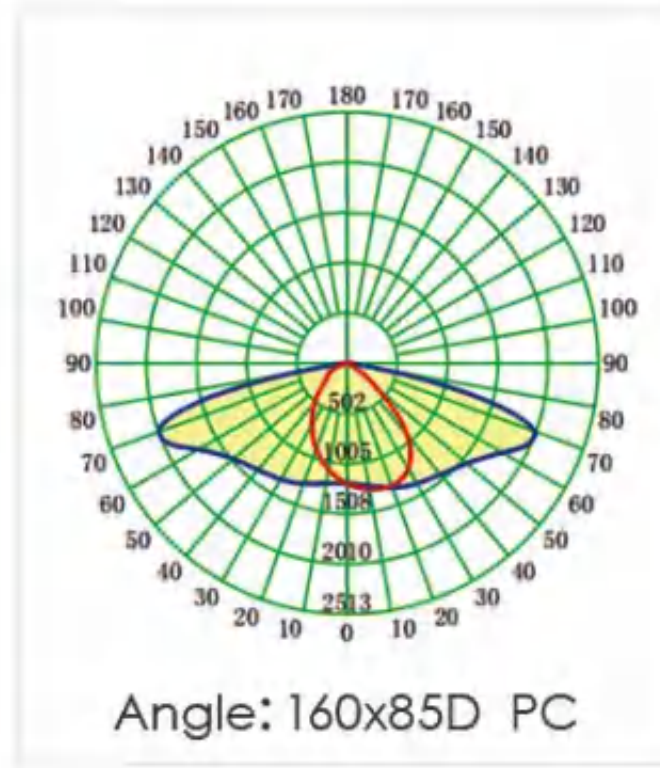

HZ-173x71-36H1-60/90D-5050

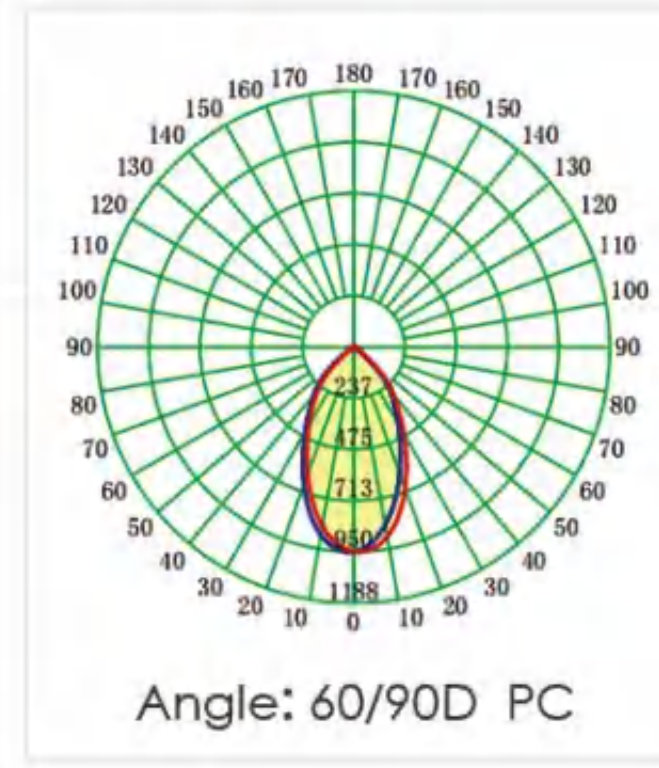

HZ-235x110-96H1-75x135D-2835/3030

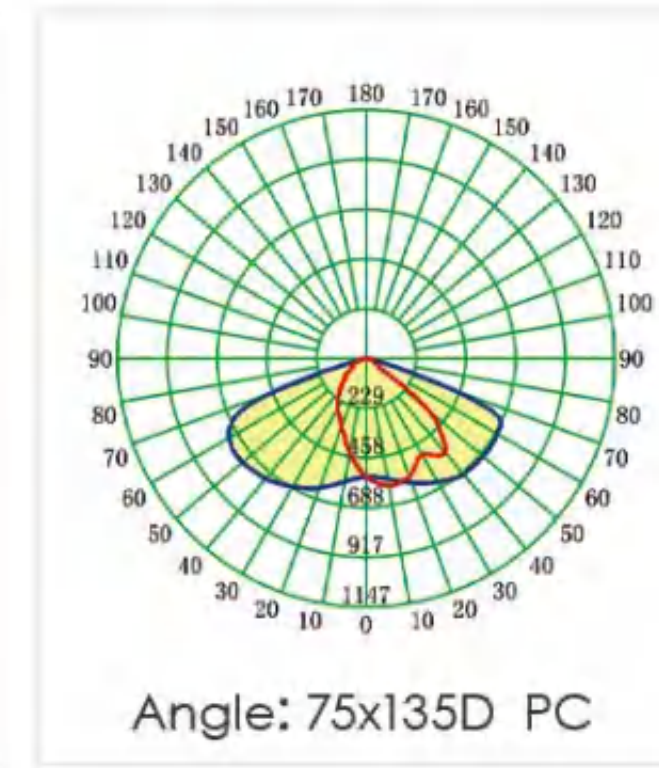

HZ-173x71-36H1-T2-S-5050

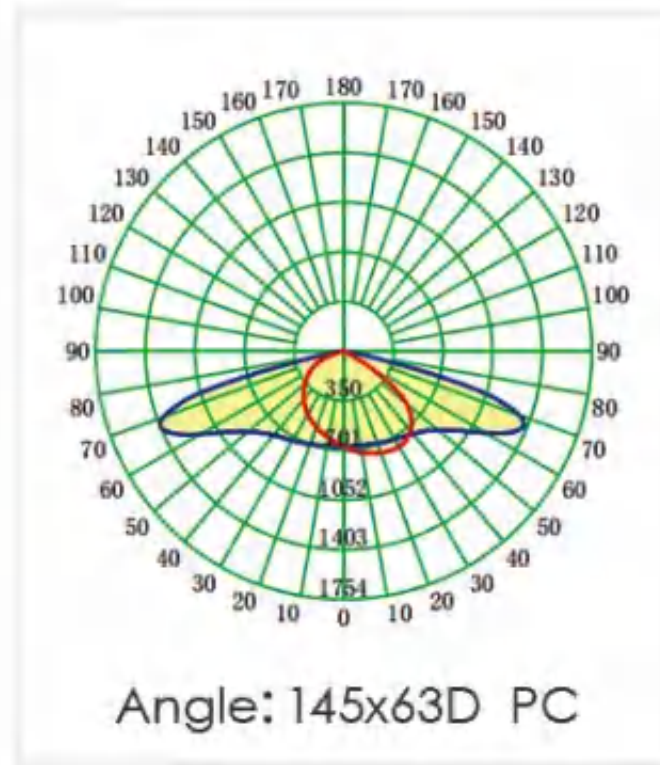

HZ-173x71-36H1-T2-H-5050

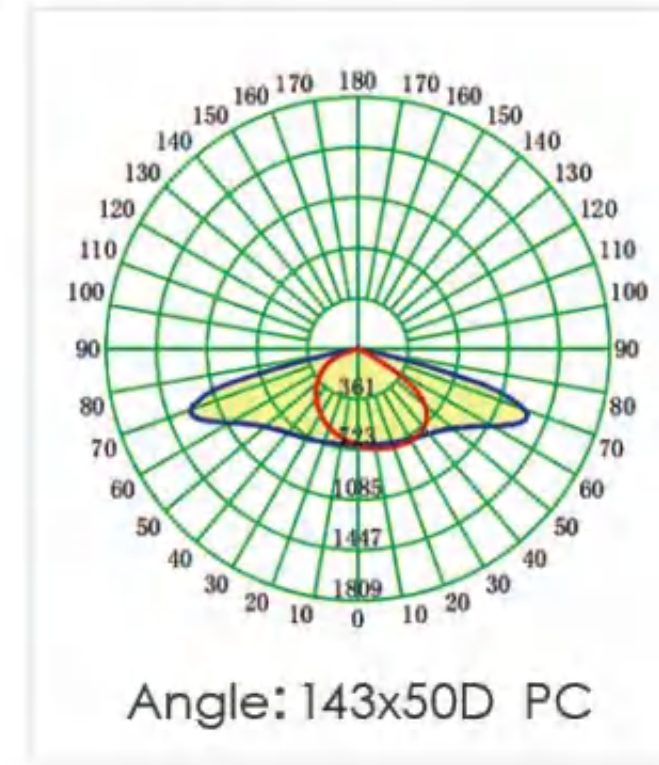

HZ-250x70-16H1-T2M-7070

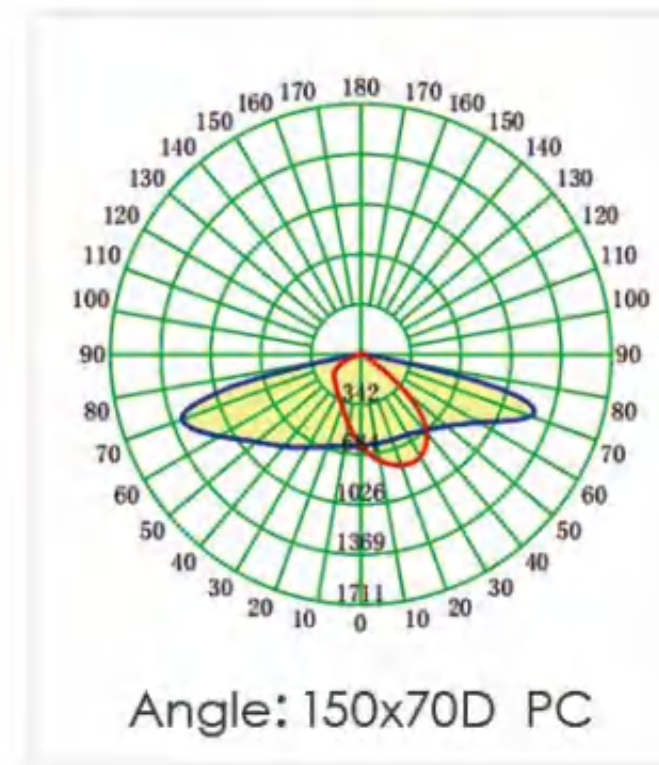
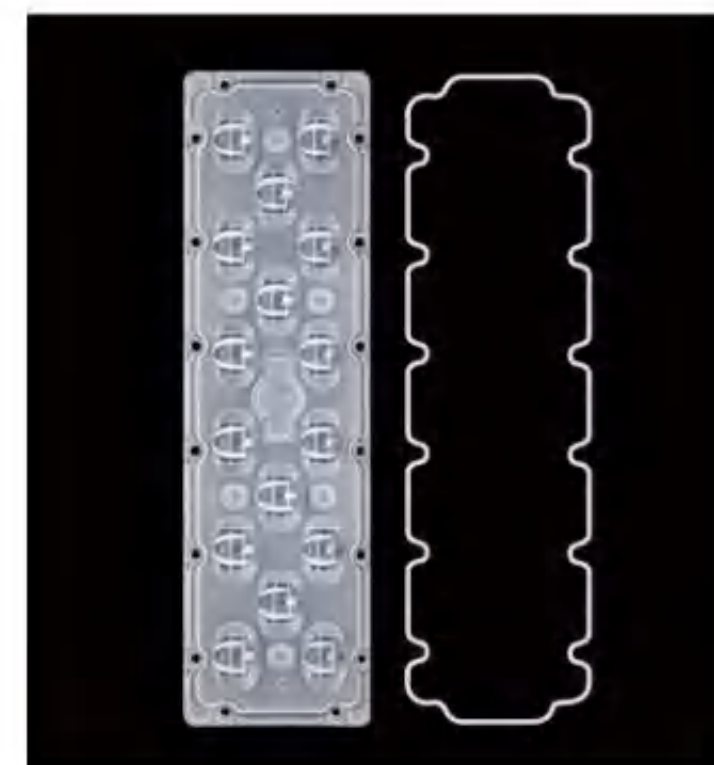

HZ-250x70-24H1-T2M-7070

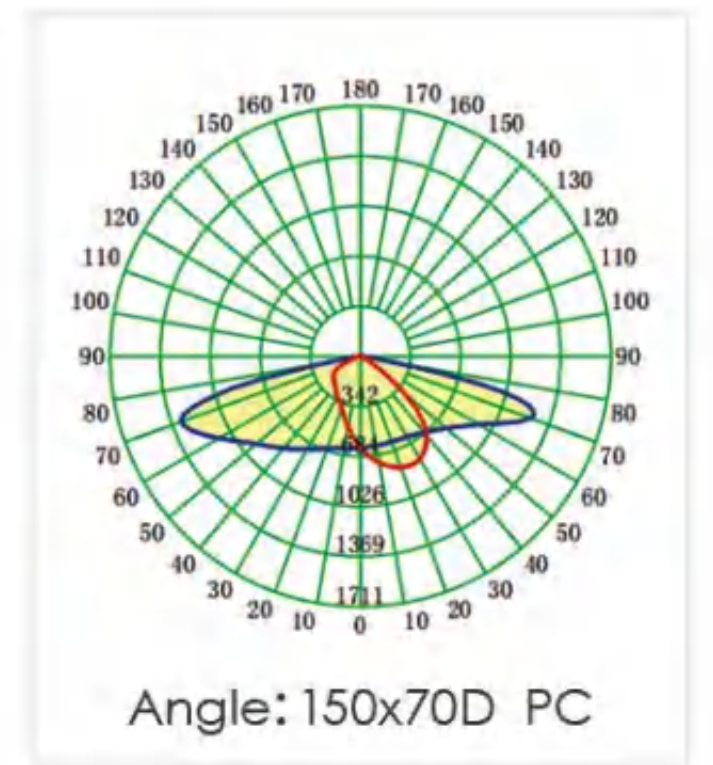

HZ-236x70-64H1-T2-3030

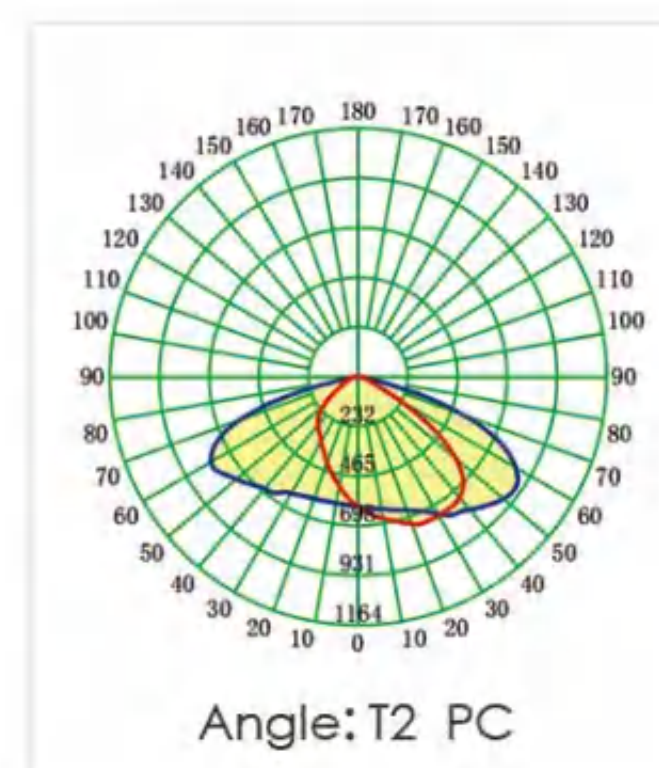

HZ-250x70-28H1-T2-2835/3030

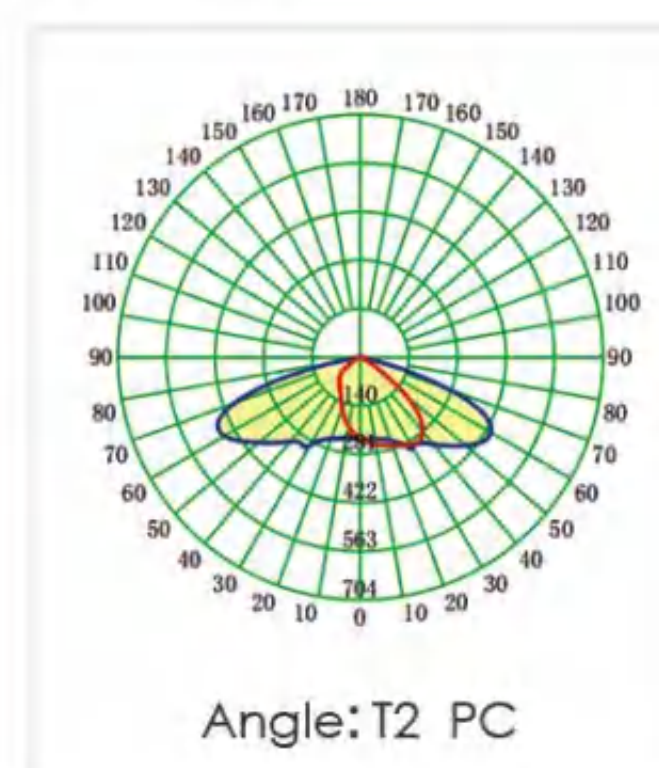

HZ-250x70-30H1-T2-2835/3030

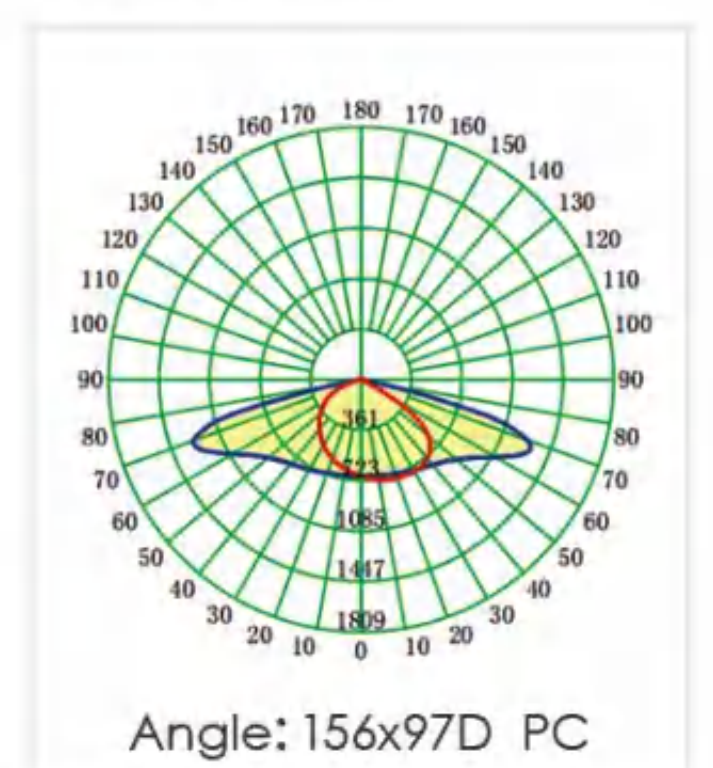

HZ-235x70-28H1-T2-2835/3030

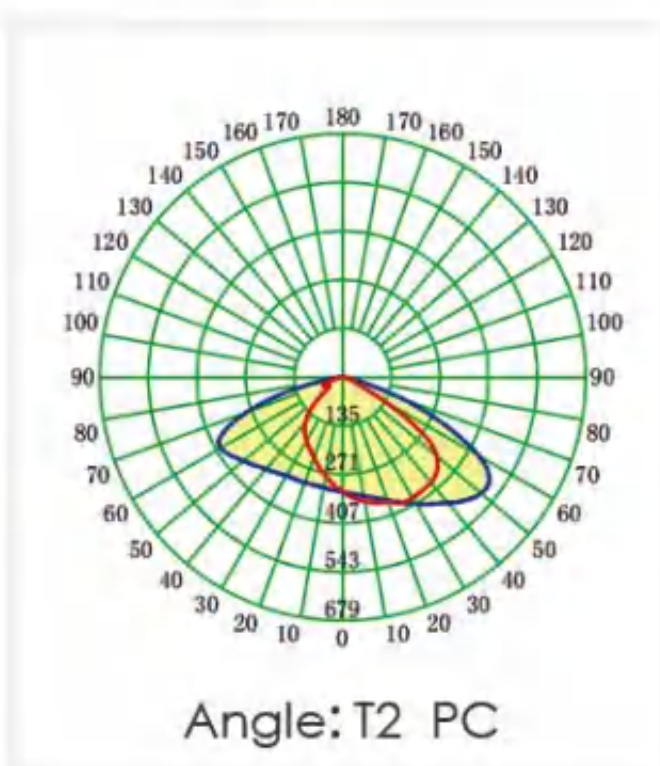

HZ-235x70-30H1-T2-2835/3030

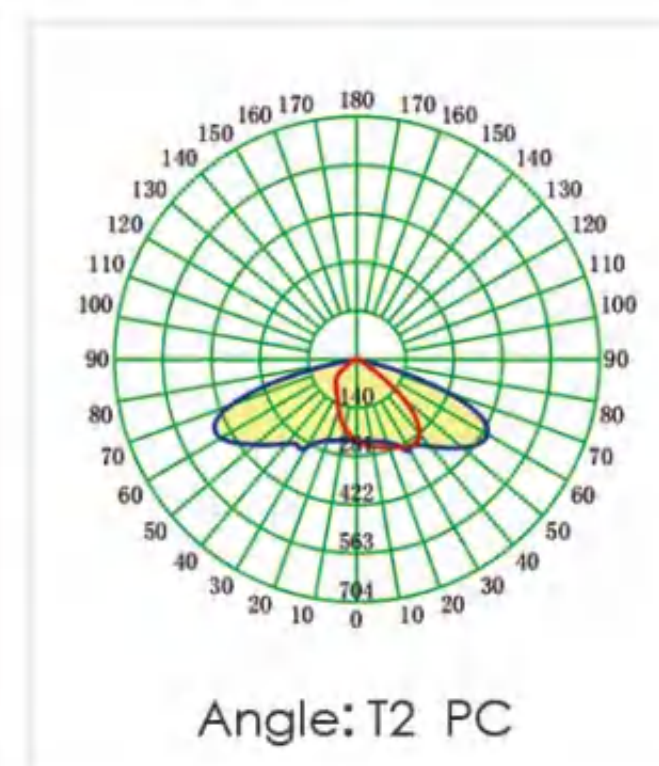

HZ-250x70-40H1-T2-2835/3030

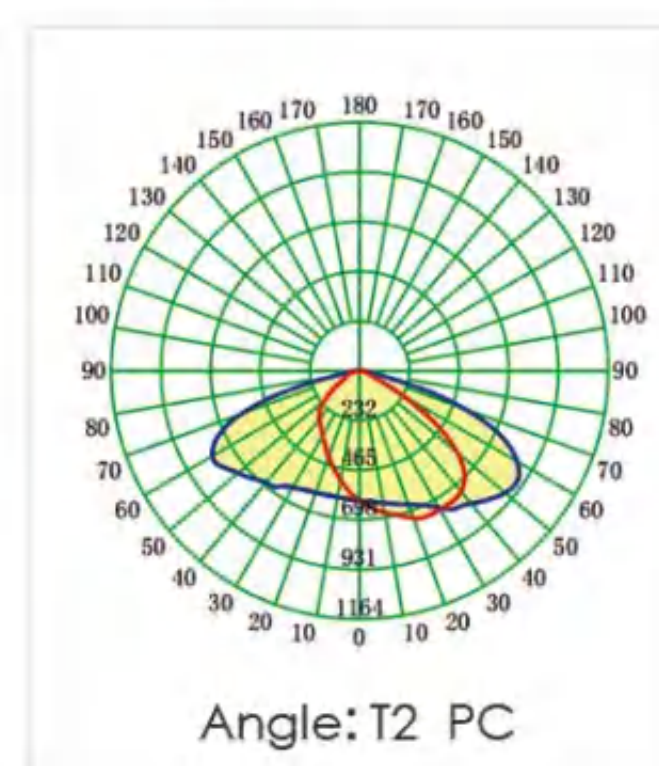

HZ-250x70-50H1-T2M-3030

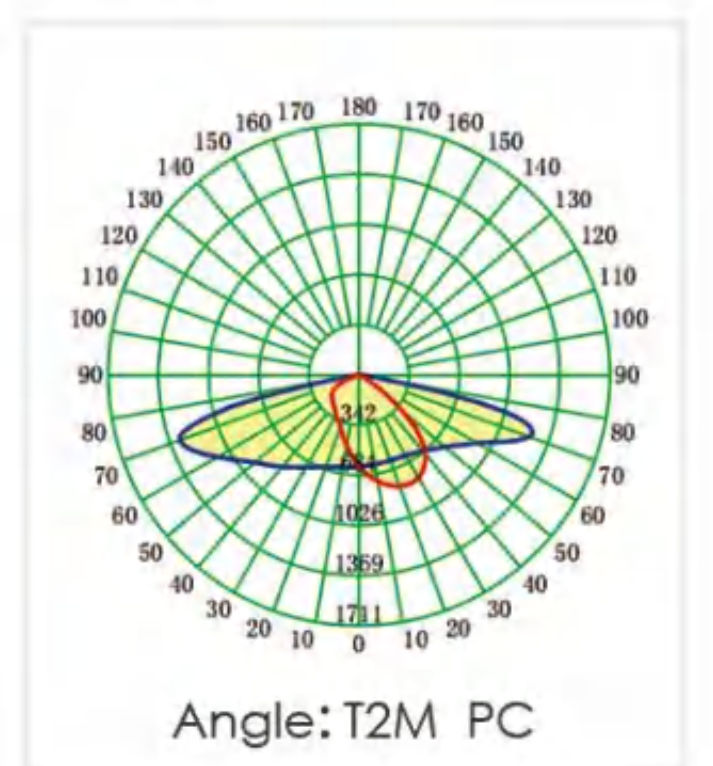



HZ-252x70-40H1-90D-3030

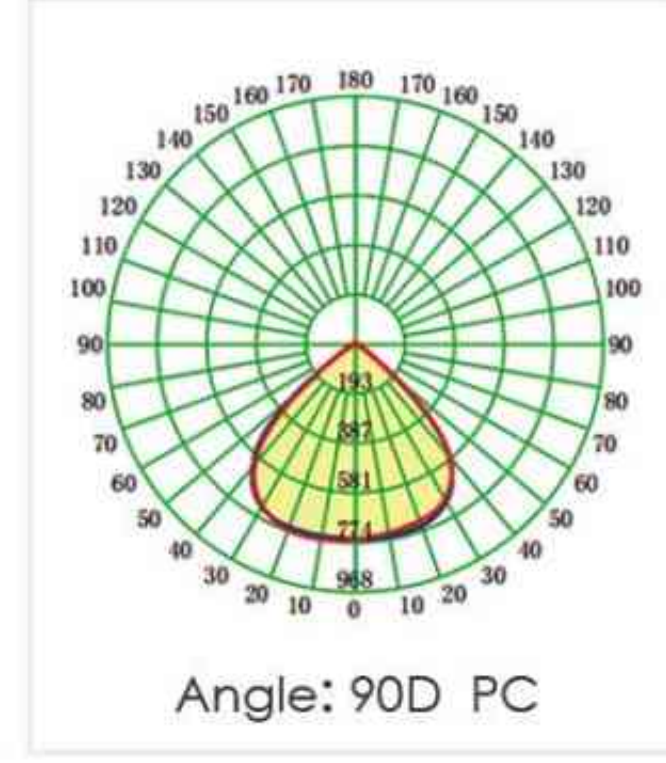

HZ-252x70-40H1-T2M-3030

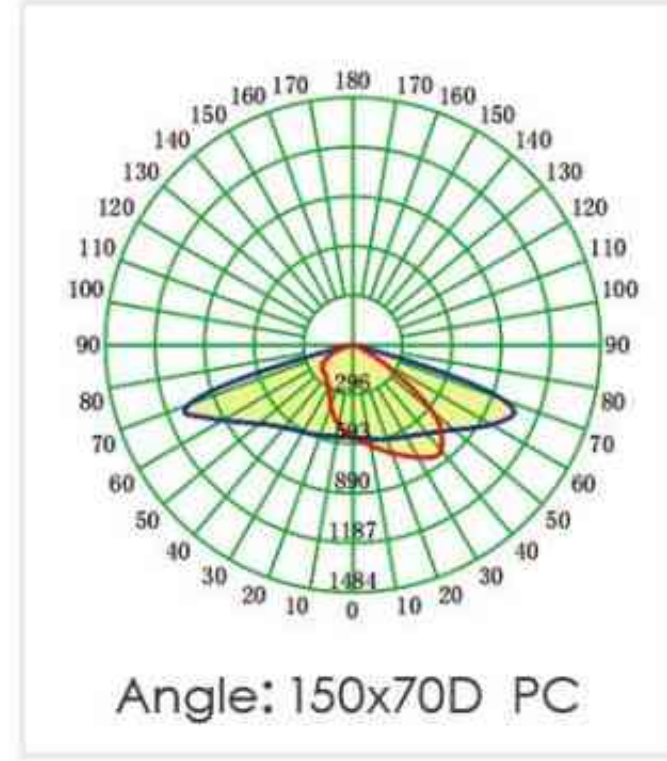

HZ-252x70-84H1-TPIIS-H-3030

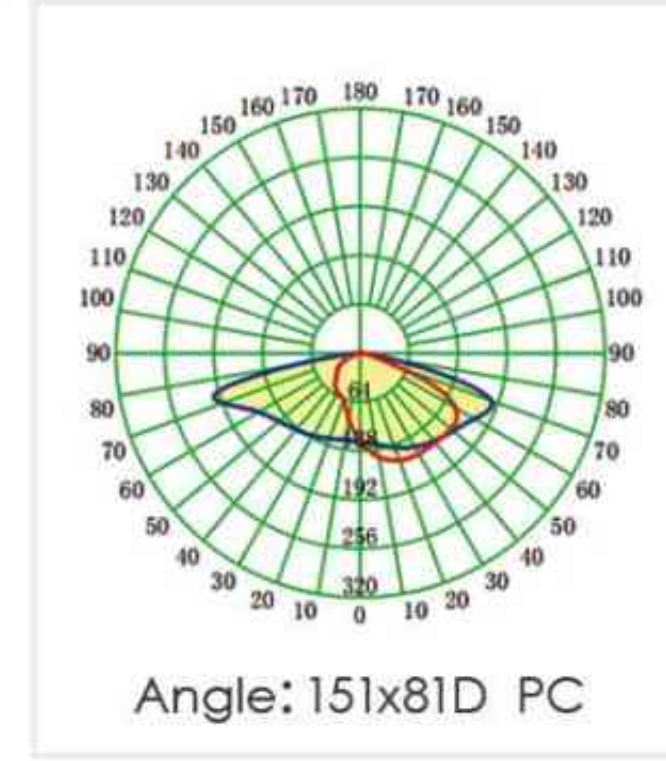

HZ-270x70-30H1-60D-3030

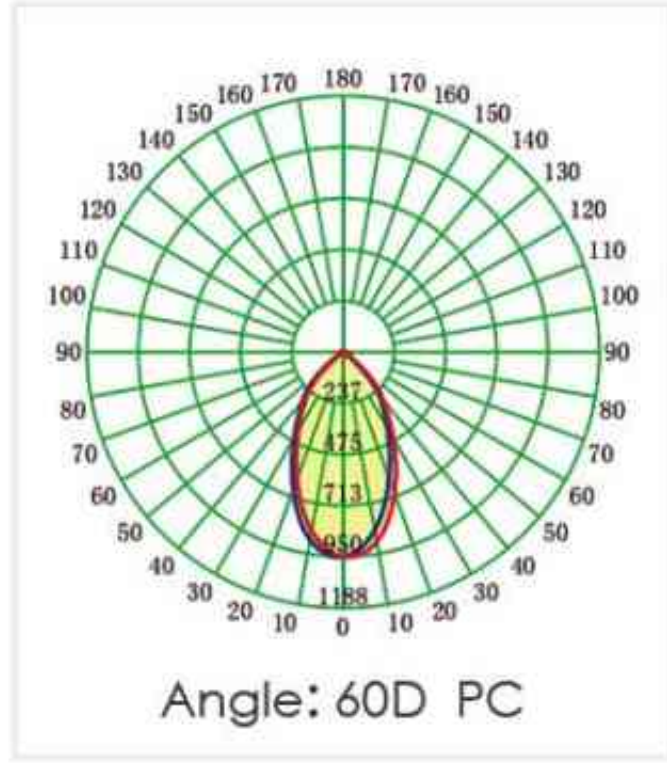

HZ-270x70-30H1-T2M-3030

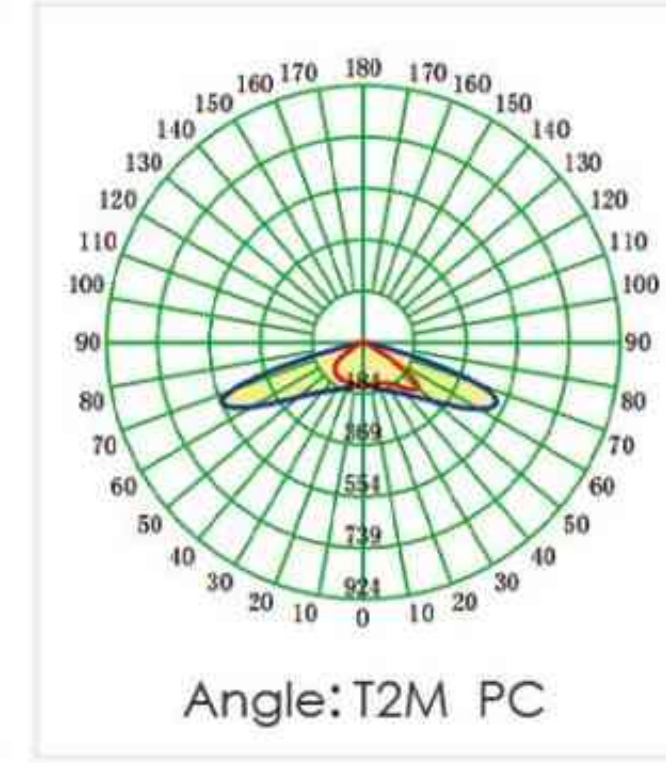

LED AYAKKABI KUTUSU IŞIK LENSİ
LED SHOEBOX LIGHT
LENS SERIES

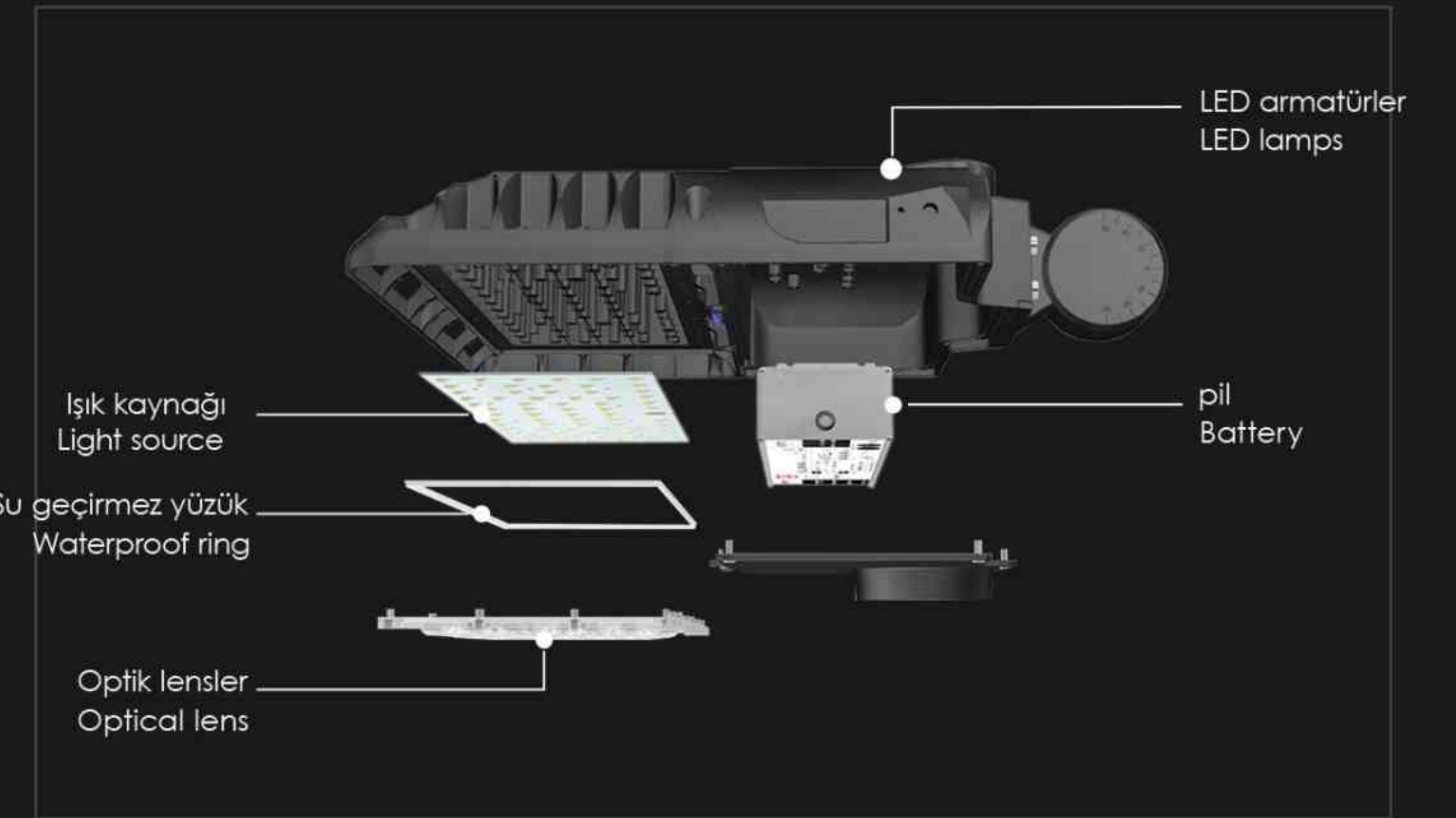



HZ-183x200-60H1-60/90D-4x3030/5050	
Boyut	183*200MM
Lamba boncukları	60
Açı	60°/90°
Malzeme	PC
Işık kaynağı	4x3030/5050

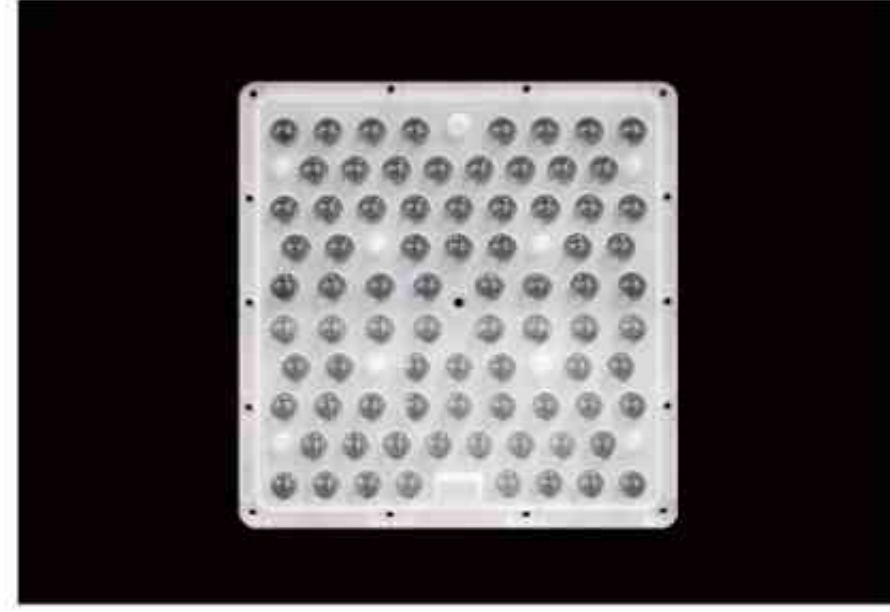

HZ-213x224-80H1-60/90D-4x3030/5050	
Boyut	213*224MM
Lamba boncukları	80
Açı	60°/90°
Malzeme	PC
Işık kaynağı	4x3030/5050

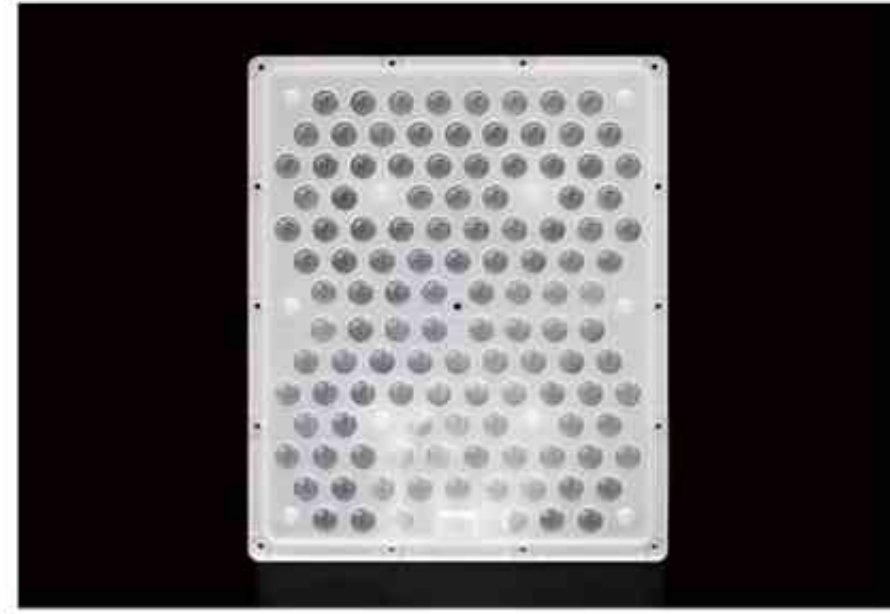

HZ-233x282-120H1-60/90D-4x3030/5050	
Boyut	233*282MM
Lamba boncukları	120
Açı	60°/90°
Malzeme	PC
Işık kaynağı	4x3030/5050

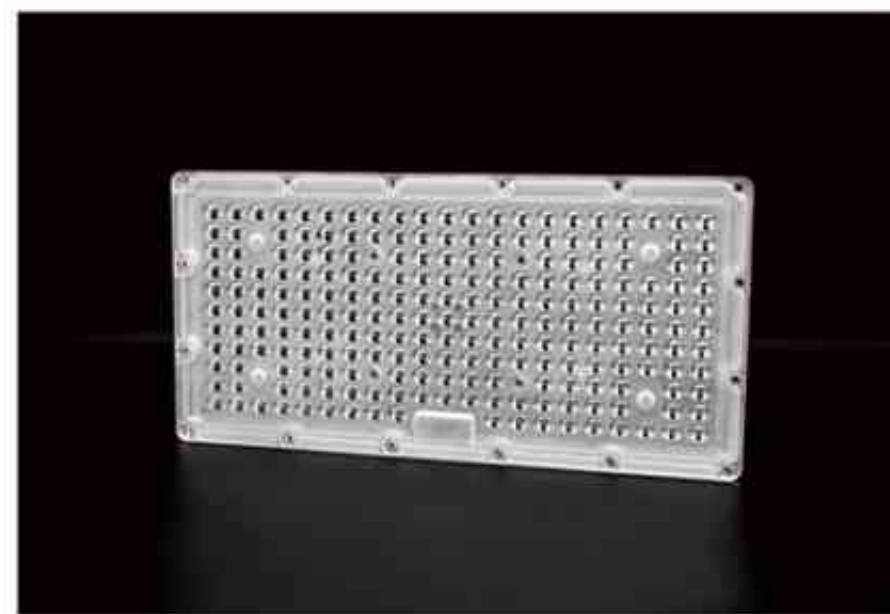

HZ-292x142-216H1-T3M-2835/3030		<p>Açısal dağılım</p>
Boyut	292*142MM	
Lamba boncukları	216	
Açı	150x80°	
Malzeme	PC	
Işık kaynağı	2835/3030	



HZ-292x181-297H1-T3-2835/3030		<p>Açısal dağılım</p>
Boyut	292*181MM	
Lamba boncukları	297	
Açı	160x80°	
Malzeme	PC	
Işık kaynağı	2835/3030	



HZ-154x171-42H1-SERIES	
Boyut	154*171MM
Lamba boncukları	42
Açı	T2-150x70°/T3M-150x90°/T4M-150x100°/T5-150x160°
Malzeme	PC
Işık kaynağı	4x3030/5050



HZ-183x200-60H1-SERIES	
Boyut	183*200MM
Lamba boncukları	60
Açı	T2-150x70°/T3M-150x90°/T4M-150x100°/T5-150x160°
Malzeme	PC
Işık kaynağı	4x3030/5050



HZ-213x224-80H1-SERIES	
Boyut	213*224MM
Lamba boncukları	80
Açı	T2-150x70°/T3M-150x90°/T4M-150x100°/T5-150x160°
Malzeme	PC
Işık kaynağı	4x3030/5050



HZ-233x282-120H1-SERIES	
Boyut	233*282MM
Lamba boncukları	120
Açı	T2-150x70°/T3M-150x90°/T4M-150x100°/T5-150x160°
Malzeme	PC
Işık kaynağı	4x3030/5050

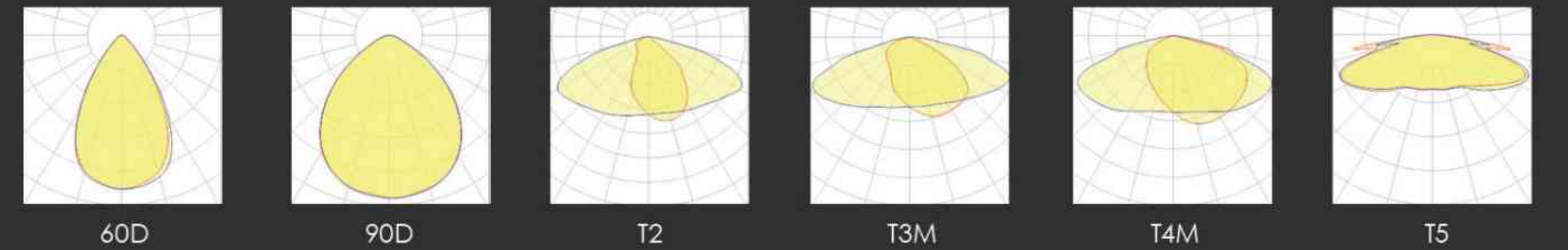



GÜNEŞ SOKAK LAMBASI LENSİ SOLAR STREET LAMP LENS

Efficient light concentration, brightness enhancement: Advanced optical design, accurate light distribution, light utilization up to 92%, brighter night!



HZ-230x85x18-2H1-140x70-9x3030		
Boyut	230*85*18MM	Açısal dağılım
Lamba boncukları	2	
Açı	140x70	
Malzeme	PC	
Işık kaynağı	3030	



LED duvar lambası lensi LED wall lamp lens series



HZ-262x160-2835/3030		
Boyut	262*160MM	Açısal dağılım
Lamba boncukları	PC	
Açı	60W	
Malzeme	2835/3030	

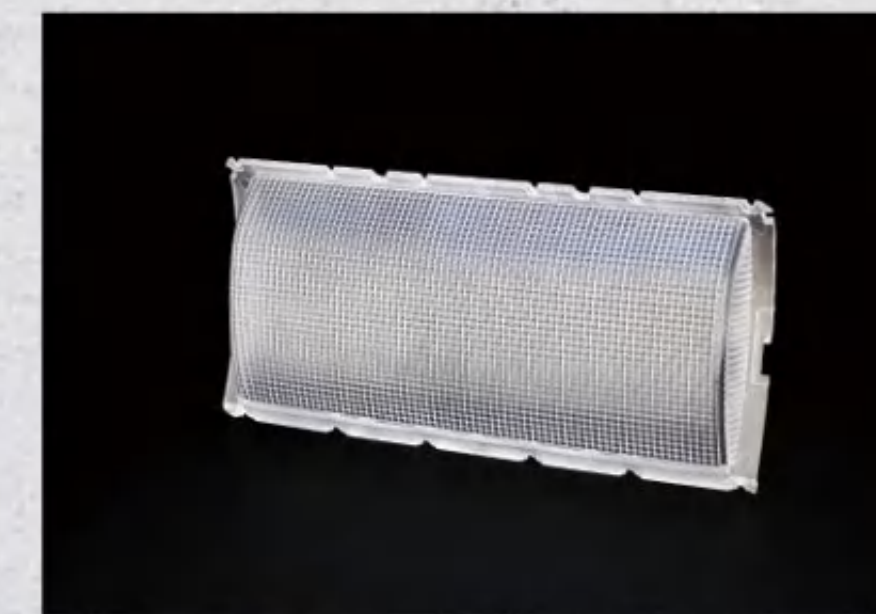

HZ-334x160-2835/3030		
Boyut	334*160MM	Açısal dağılım
Lamba boncukları	PC	
Açı	120W	
Malzeme	2835/3030	



UFO

Yüksek ışık geçirgenliğine sahip lens

High light transmission lens

Widely used in high-shed workshop, workshop, warehouse, exhibition hall, gymnasium, waiting room, station airport, shopping malls, hypermarkets, outdoor buildings and other places of lighting.

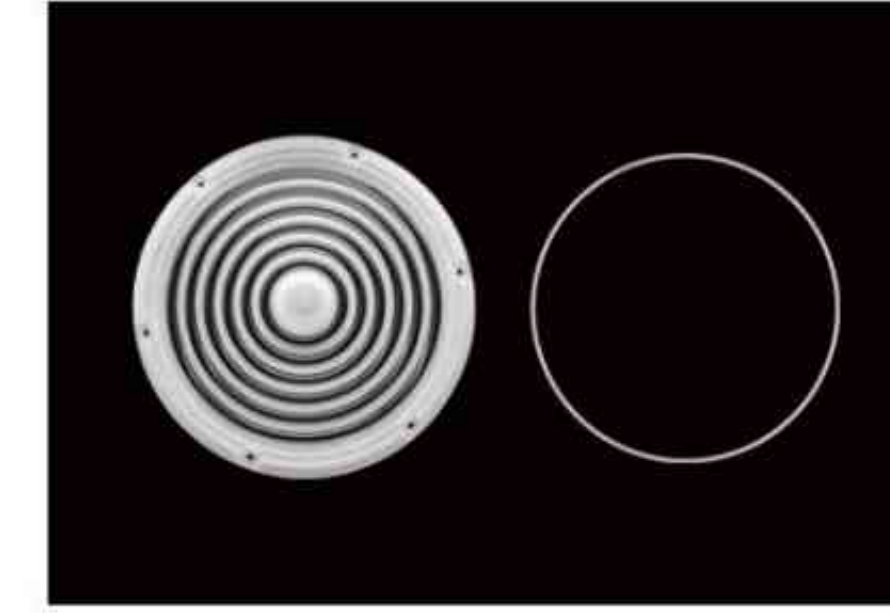

HZ-184

Boyut	Ø184MM	Açısal dağılım		
Açı	60°/90°/120°			
Malzeme	PC			
Işık kaynağı	2835/3030			
Watt	100W			

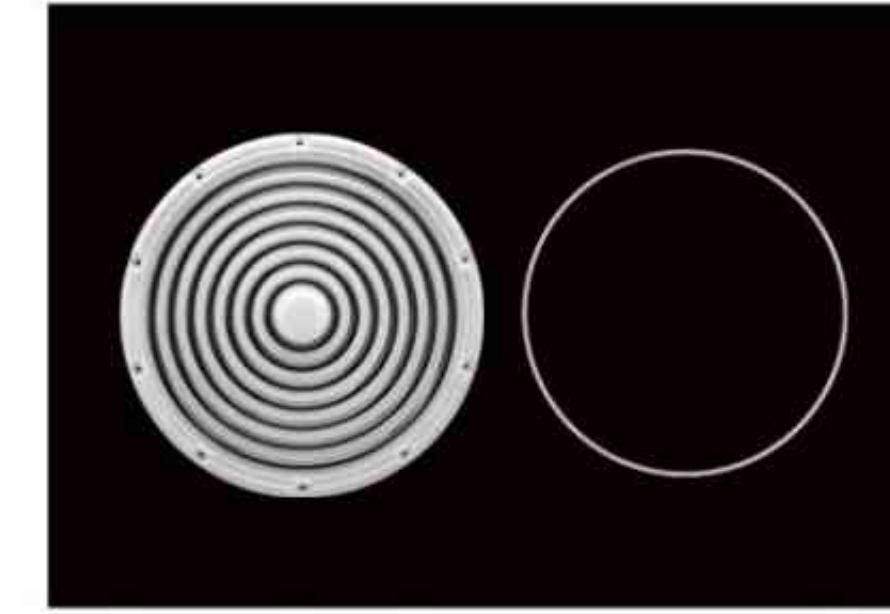

HZ-226

Boyut	Ø226MM	Açısal dağılım		
Açı	60°/90°/120°			
Malzeme	PC			
Işık kaynağı	2835/3030			
Watt	150W			

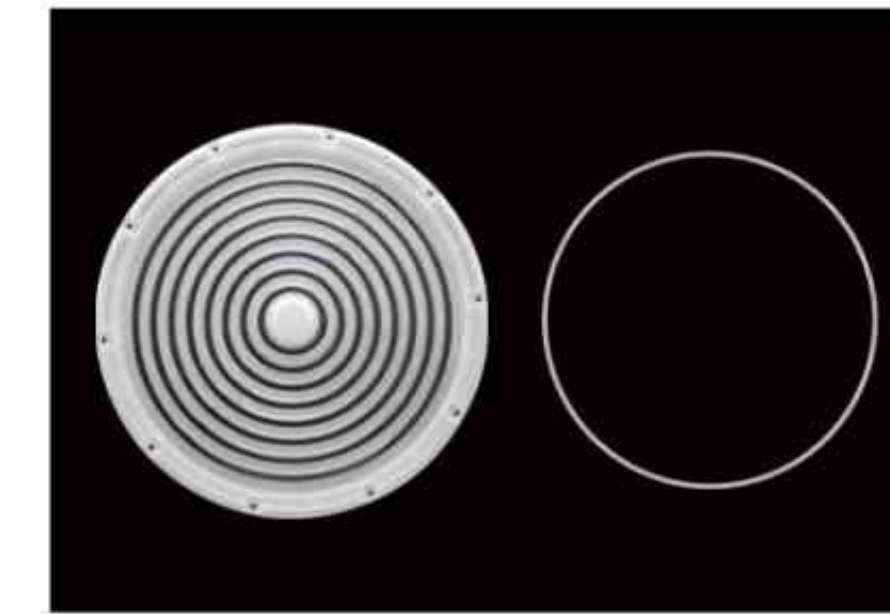

HZ-265

Boyut	Ø265MM	Açısal dağılım		
Açı	60°/90°/120°			
Malzeme	PC			
Işık kaynağı	2835/3030			
Watt	200W			

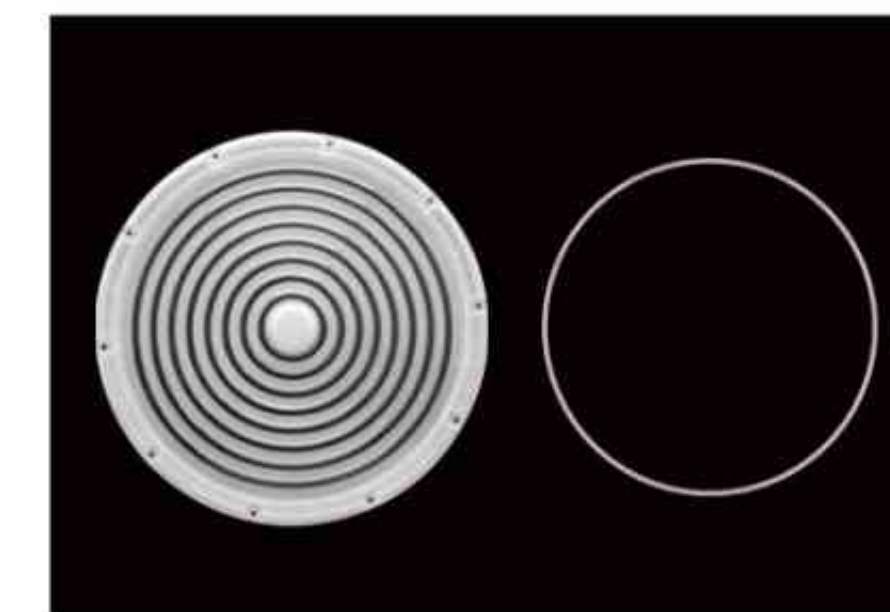

HZ-293

Boyut	Ø293MM	Açısal dağılım		
Açı	60°/90°/120°			
Malzeme	PC			
Işık kaynağı	2835/3030			
Watt	240W			

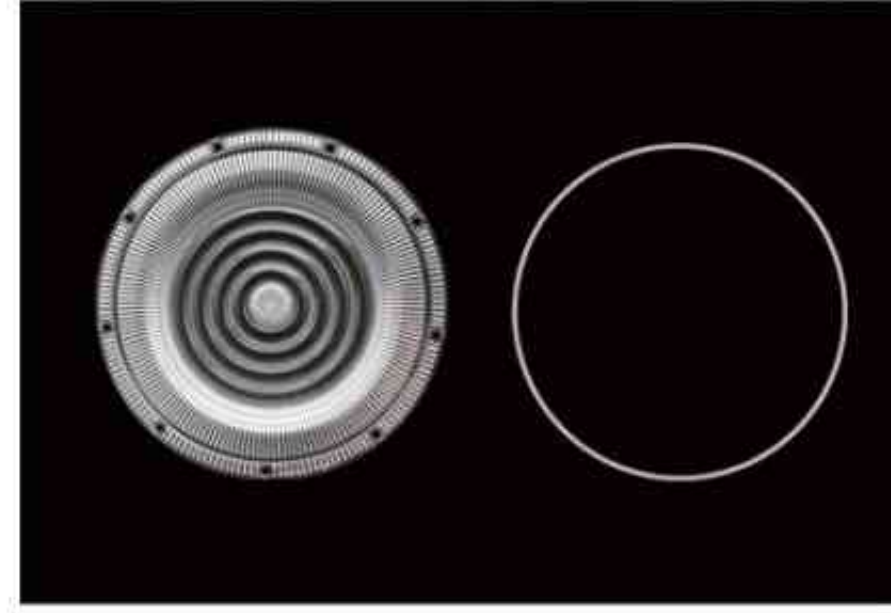

HZ-DOB-213		Açısal dağılım		
Boyut	Ø213MM			
Açı	60°/90°/120°	60°	90°	120°
Malzeme	PC			
Işık kaynağı	2835/3030			
Watt	100W			



HZ-GY-184		Açısal dağılım	
Boyut	Ø184MM		
Açı	60°/90°	60°	90°
Malzeme	PC		
Işık kaynağı	2835/3030		
Watt	100W		

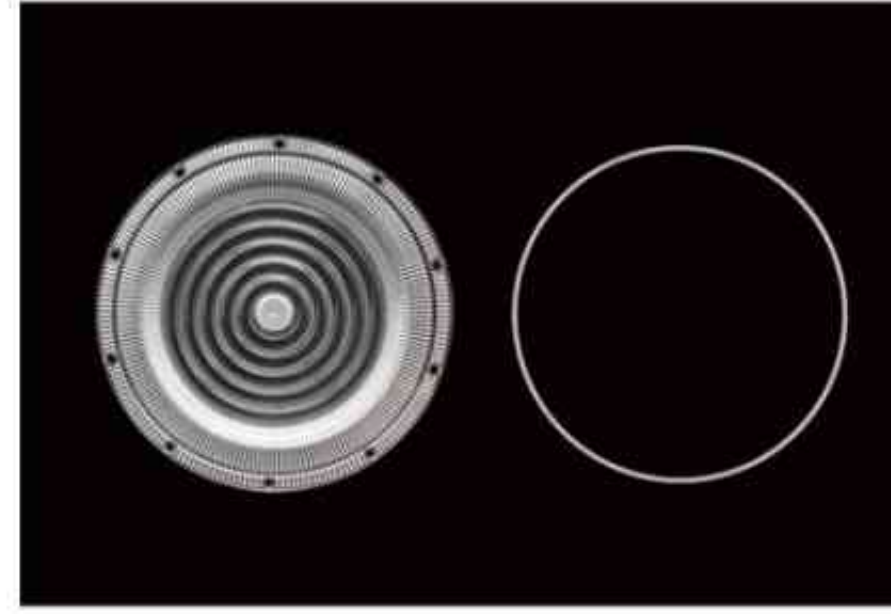

HZ-DOB-237		Açısal dağılım		
Boyut	Ø237MM			
Açı	60°/90°/120°	60°	90°	120°
Malzeme	PC			
Işık kaynağı	2835/3030			
Watt	150W			

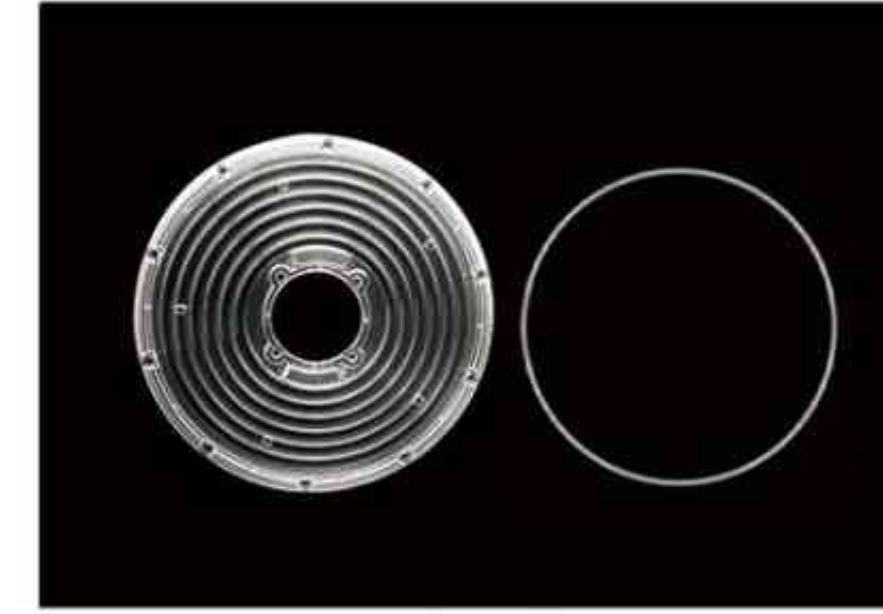

HZ-GY-226		Açısal dağılım		
Boyut	Ø226MM			
Açı	60°/90°/120°	60°	90°	120°
Malzeme	PC			
Işık kaynağı	2835/3030			
Watt	150W			

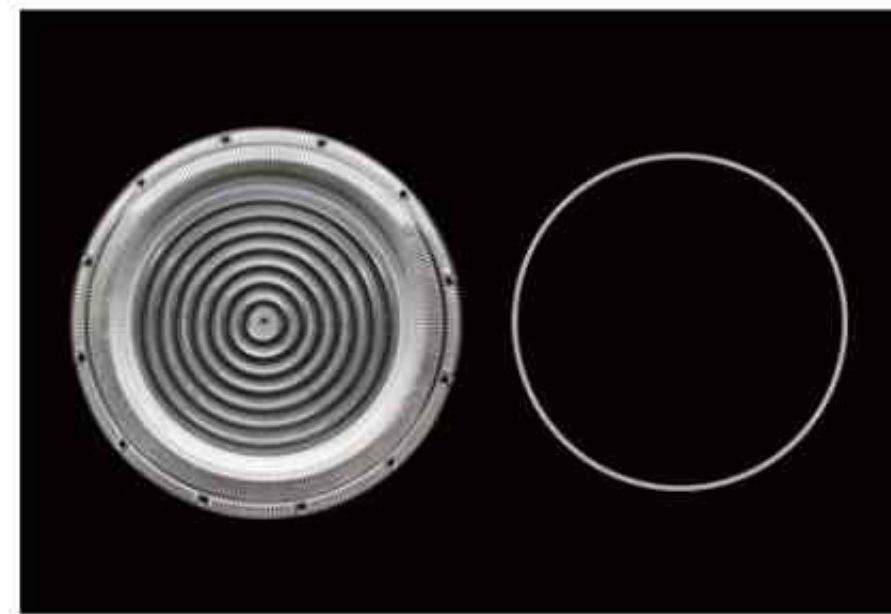

HZ-DOB-260		Açısal dağılım		
Boyut	Ø260MM			
Açı	60°/90°/120°	60°	90°	120°
Malzeme	PC			
Işık kaynağı	2835/3030			
Watt	200W			

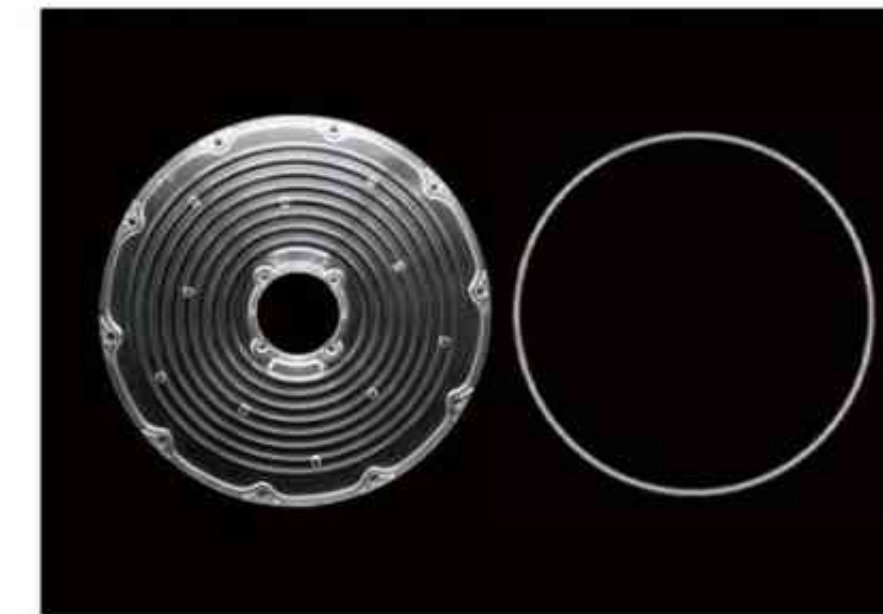

HZ-GY-265		Açısal dağılım		
Boyut	Ø265MM			
Açı	60°/75°/90°/120°	60°	90°	120°
Malzeme	PC			
Işık kaynağı	2835/3030			
Watt	200W			

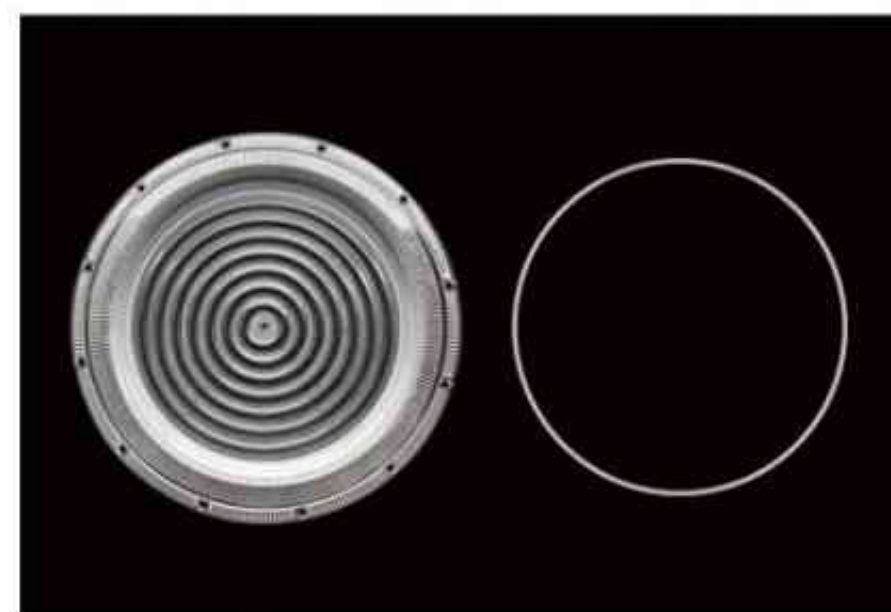

HZ-DOB-305		Açısal dağılım		
Boyut	Ø305MM			
Açı	60°/90°/120°	60°	90°	120°
Malzeme	PC			
Işık kaynağı	2835/3030			
Watt	300W			

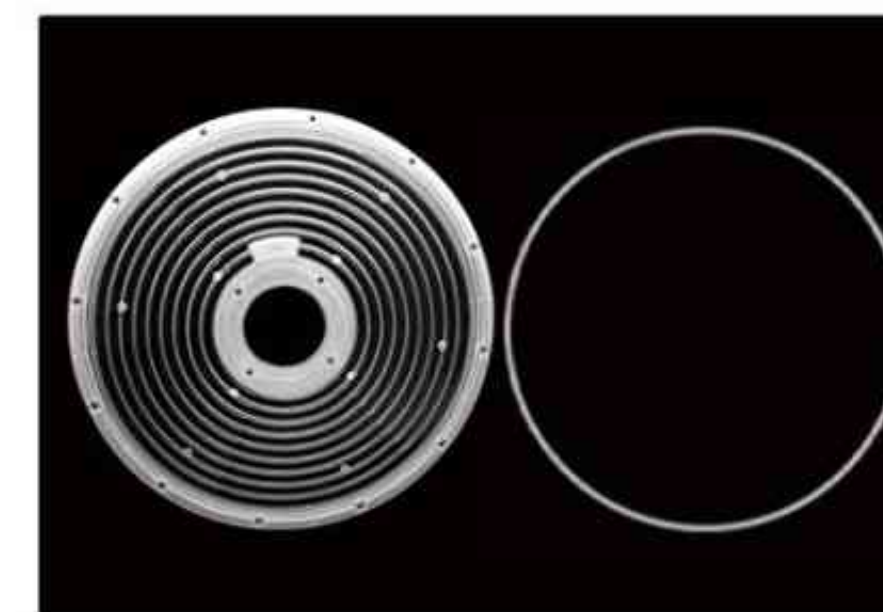

HZ-GY-293		Açısal dağılım	
Boyut	Ø293MM		
Açı	60°/90°	60°	90°
Malzeme	PC		
Işık kaynağı	2835/3030		
Watt	240W		



Optik reflektör serisi Optical Reflective Cup Series



HZ-45-H32.7

Boyut	Φ45*H32.7MM
Malzeme	PC kaplama/PC plating
Açı	15°/ 24°/ 36°/ 45°/ 60°
Işık kaynağı	CXA-13/CXA-15/CXM-9/S9/CLL026
Aydınlık yüzeyler	17.4



HZ-50-H32.2

Boyut	Φ50*H32.2MM
Malzeme	PC kaplama/PC plating
Açı	15°/ 24°/ 36°/ 45°/ 60°
Işık kaynağı	CXA-13/CXA-15/CXM-9/S9/CLL026
Aydınlık yüzeyler	18



HZ-63-H41

Boyut	Φ63*H41MM
Malzeme	PC kaplama/PC plating
Açı	15°/ 24°/ 36°/ 45°/ 60°
Işık kaynağı	CXA-15/CXA-18/CXA-25/CXM-9/CXM-14/CLL026/CLL036
Aydınlık yüzeyler	25.88



HZ-69-H41.6

Boyut	Φ69*41.6MM
Malzeme	PC kaplama/PC plating
Açı	15°/ 24°/ 36°/ 45°/ 60°
Işık kaynağı	CXA-15/CXA-18/CXA-25/CXM-9/CXM-14/CLL026/CLL036
Aydınlık yüzeyler	24.8



HZ-75-H43.2

Boyut	Φ75*H43.2MM
Malzeme	PC电镀/PC plating
Açı	15°/ 24°/ 36°/ 45°/ 60°
Işık kaynağı	CXA-15/CXA-18/CXA-25/CXM-9/CXM-14/CLL026/CLL036
Aydınlık yüzeyler	24.8



HZ-83-H49.23

Boyut	Φ83*H49.23MM
Malzeme	PC kaplama/PC plating
Açı	15°/ 24°/ 36°/ 45°/ 60°
Işık kaynağı	CXA-15/CXA-18/CXA-25/CXM-9/CXM-14/CLL026/CLL036
Aydınlık yüzeyler	24.8



HZ-92-H49.23

Boyut	Φ92*H49.23MM
Malzeme	PC kaplama/PC plating
Açı	15°/ 24°/ 36°/ 45°/ 60°
Işık kaynağı	CXA-18/CXA-25/CLL036/CLL046
Aydınlık yüzeyler	33.2

Yukarıdaki 7 tür açılı ışık kaynağı
The above 7 types of Angle light pattern

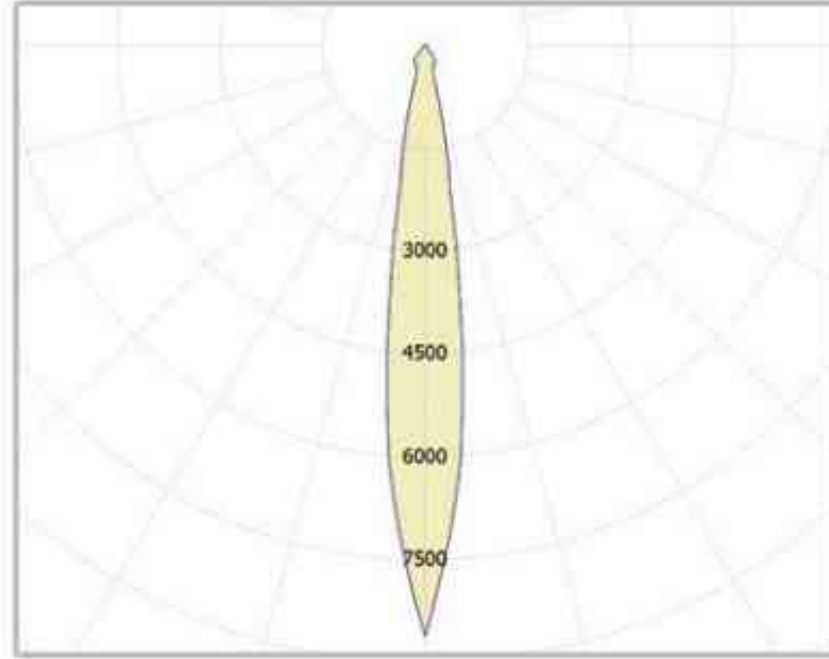

15°

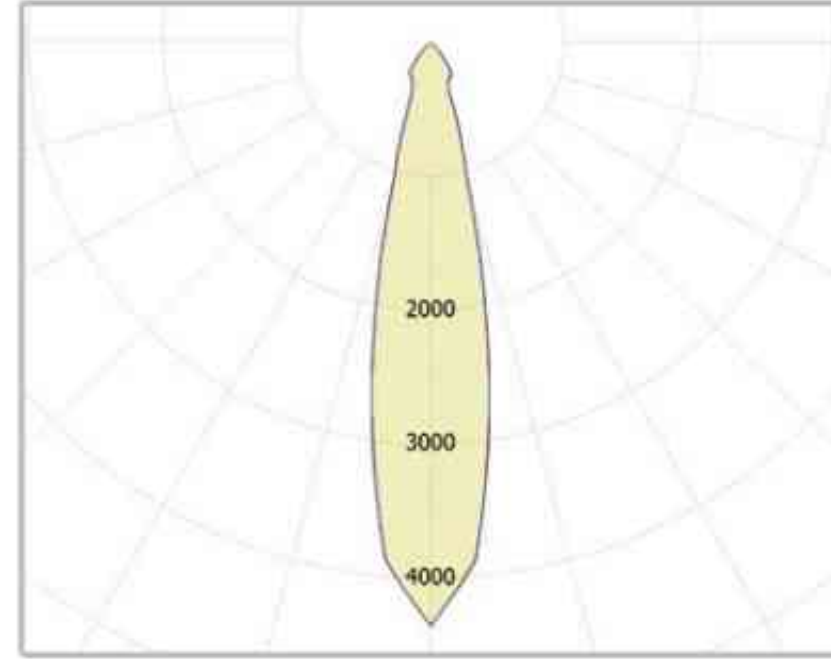

24°

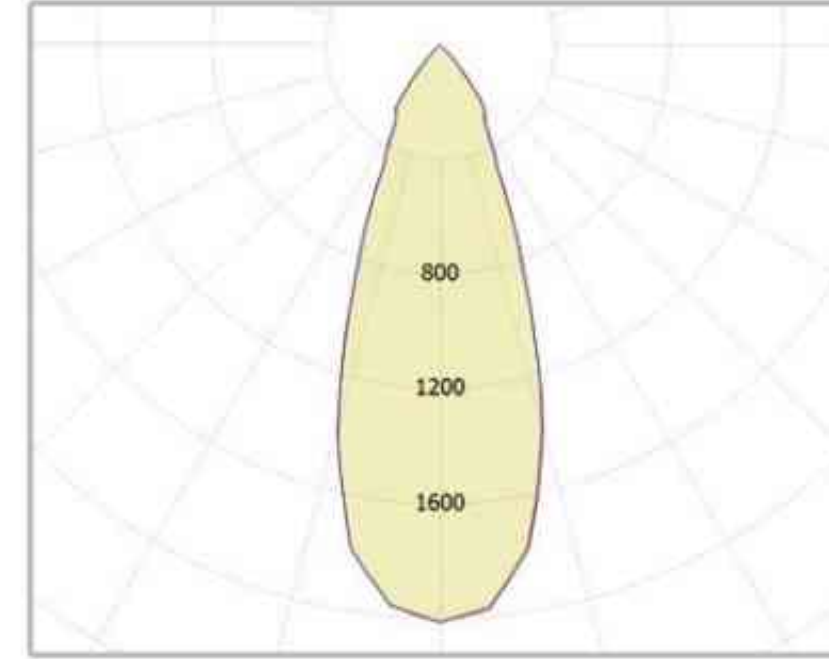

36°

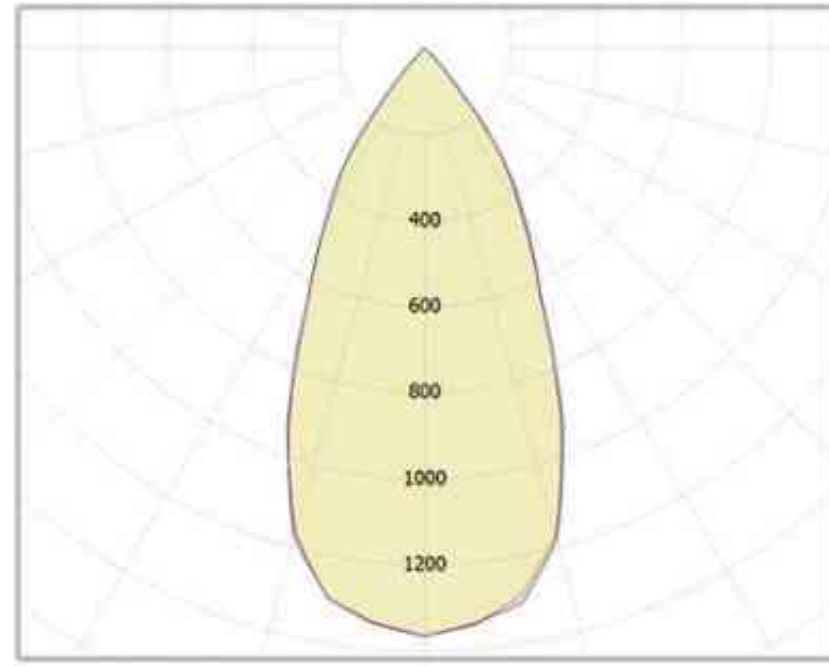

45°

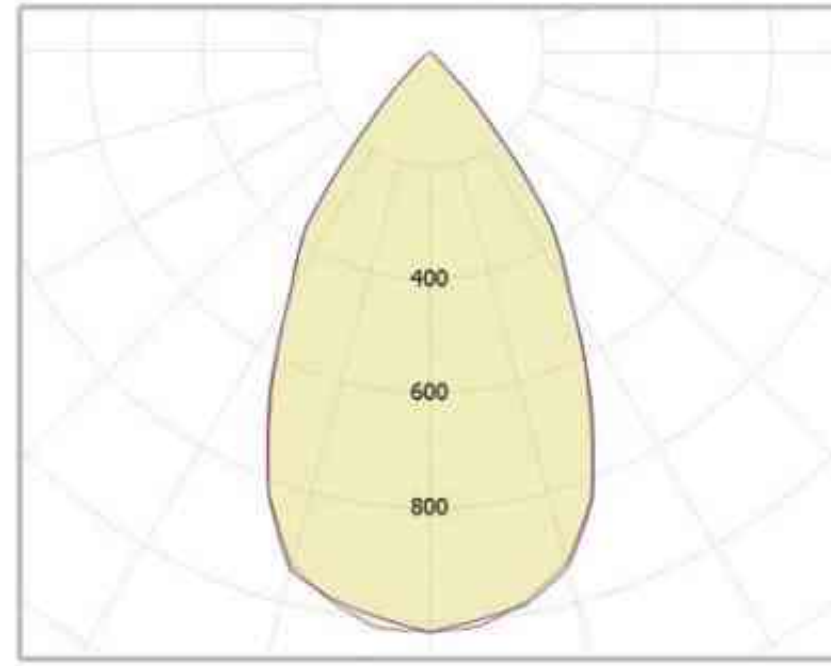

60°



Optical reflector/Optik reflektörler



HZ-45-36

Boyut	Φ45*H36MM
Malzeme	PC
Açı	38°
Işık kaynağı	CXM-9

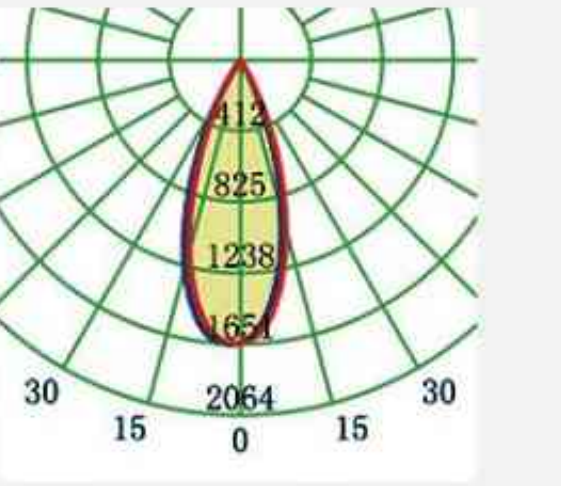

HZ-50-24.3

Boyut	Φ50*H24.3MM
Malzeme	PC
Açı	45°
Işık kaynağı	CXM-9
Parantez	Eşleşen/Normal



Tavan lambası merceği Ceiling light lens

LED optical ceiling light lens
LED OPTİK TAVAN LAMBASI LENSİ



HZ-125	
Boyut	Φ125MM
Malzeme	PC
Lamba boncukları	56
Işık kaynağı	2835/3030
Açı	160



HZ-160	
Boyut	Φ160MM
Malzeme	PC
Lamba boncukları	56
Işık kaynağı	2835/3030
Açı	160



HZ-130	
Boyut	Φ130MM
Malzeme	PC
Lamba boncukları	56
Işık kaynağı	2835/3030
Açı	160

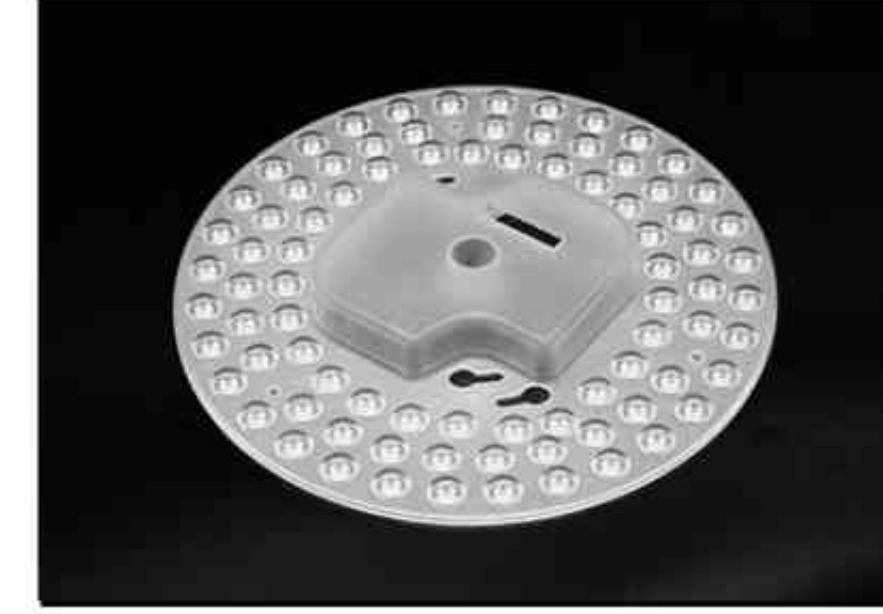

HZ-169	
Boyut	Φ169MM
Malzeme	PC
Lamba boncukları	84
Işık kaynağı	2835/3030
Açı	160



HZ-174	
Boyut	Φ174MM
Malzeme	PC
Lamba boncukları	56
Işık kaynağı	2835/3030
Açı	160



HZ-239	
Boyut	Φ239MM
Malzeme	PC
Lamba boncukları	84
Işık kaynağı	2835/3030
Açı	160

Çizgi ışıklı mercek Line light lens series

Flexible lighting foldable background wall condenser
chandelier magnetic track light

Esnek aydınlatma, katlanır arka plan duvar, spot ışığı, avize, manyetik
parça ışığı

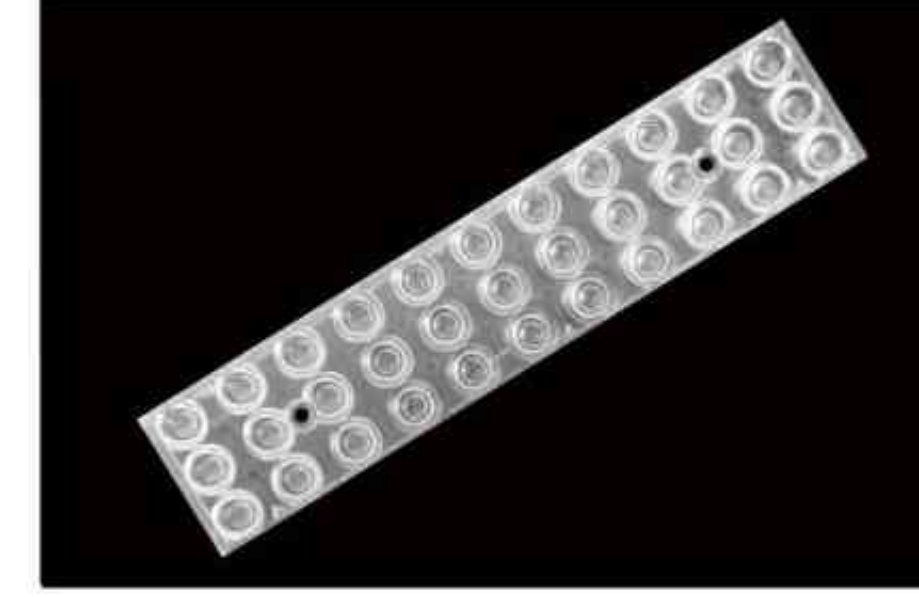

HZ-33H1-286x61x9.7-I

Boyut	286*61*9.7MM
Açı	30°/60°/90°
Malzeme	PC/PMMA
Işık kaynağı	2835/3030
Lamba boncukları	33

Açısal dağılım

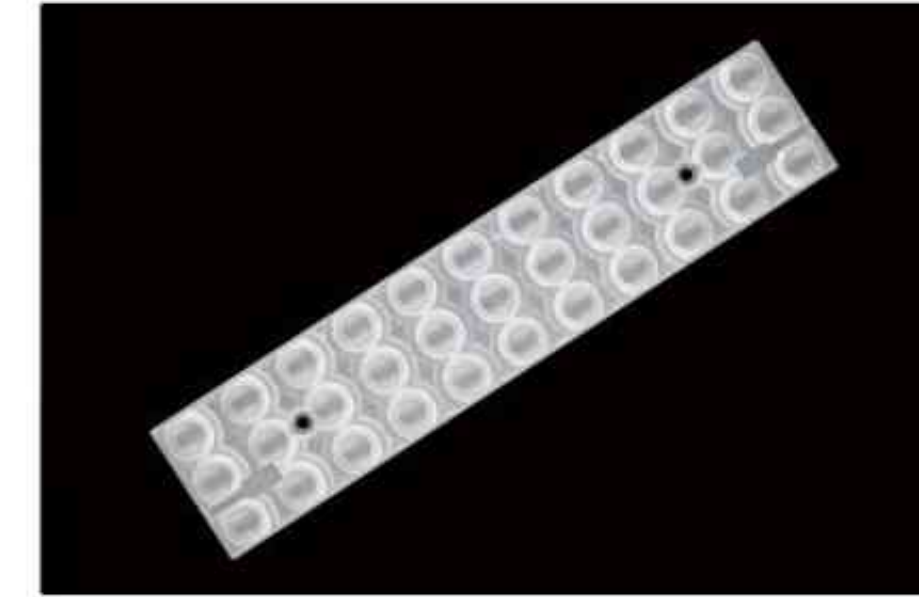

HZ-33H1-286x61x7.5-III

Boyut	286*61*7.5MM
Açı	60°/90°/120°
Malzeme	PC/PMMA
Işık kaynağı	2835/3030
Lamba boncukları	33

Açısal dağılım

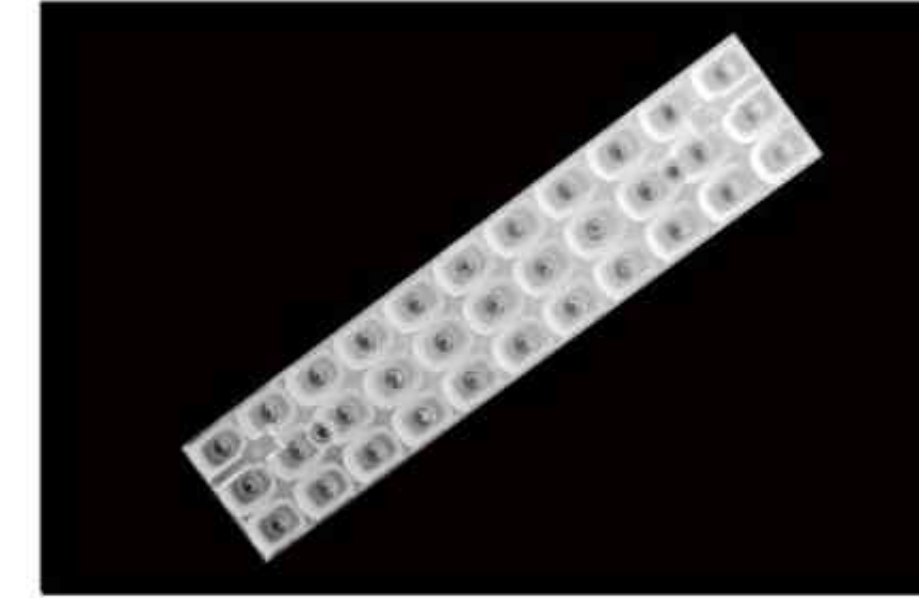

HZ-33H1-286x61x7.6

Boyut	286*61*7.6MM
Açı	80x65°/90°
Malzeme	PC/PMMA
Işık kaynağı	2835/3030
Lamba boncukları	33

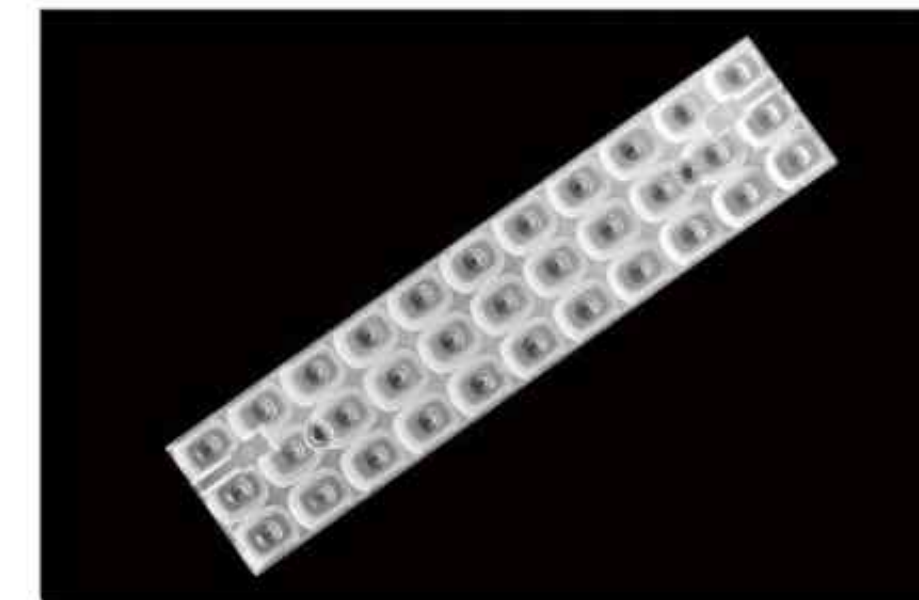

HZ-33H1-286x61x8.2

Boyut	286*61*8.2MM
Açı	70x35°
Malzeme	PC/PMMA
Işık kaynağı	2835/3030
Lamba boncukları	33

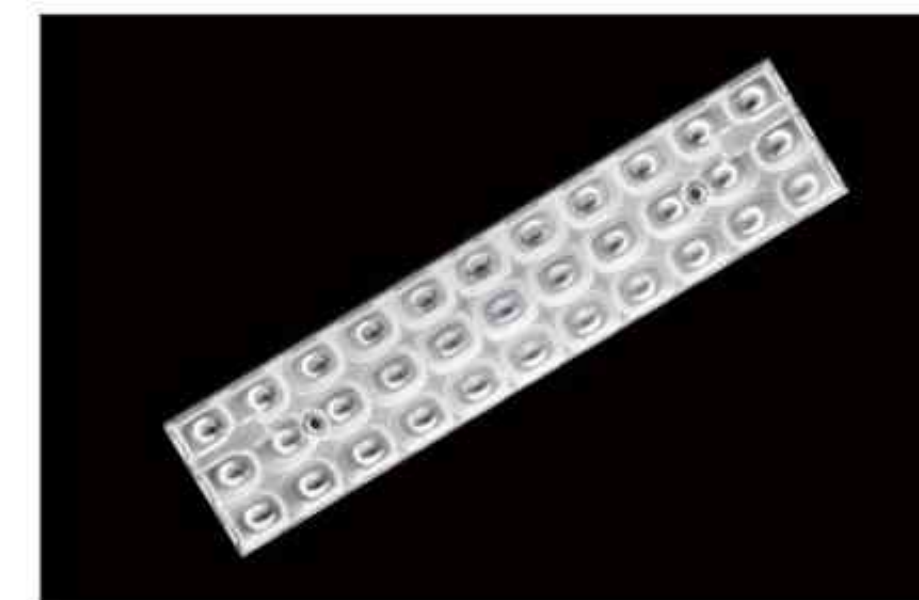

HZ-33H1-286x61x7.5

Boyut	286*61*7.5MM
Açı	LR25/LR30/P20
Malzeme	PC/PMMA
Işık kaynağı	2835/3030
Lamba boncukları	33



HZ-283.5*40-30*90D	
Boyut	283.5x40MM
Açı	30X90°
Malzeme	PC
Işık kaynağı	2835/3030/5630/5050



HZ-283.5*40-60*90D	
Boyut	283.5x40MM
Açı	60x90°
Malzeme	PC
Işık kaynağı	2835/3030/5630/5050



HZ-283.5*40-90*100D	
Boyut	283.5x40MM
Açı	90x100°
Malzeme	PC
Işık kaynağı	2835/3030/5630/5050



HZ-283.5*40-P20D	
Boyut	283.5x40MM
Açı	P20°
Malzeme	PC
Işık kaynağı	2835/3030/5630/5050



HZ-283.5*40-LR20D	
Boyut	283.5x40MM
Açı	LR20°
Malzeme	PC
Işık kaynağı	2835/3030/5630/5050



Çizgi ışıklı lens serisi LINE LIGHT LENS SERIES

Shopping malls, warehouses garages basements and other indoor lighting lenses

Alışveriş merkezleri, depolar, garajlar, bodrumlar vb. için iç mekan aydınlatma lensleri



The light is uniform and not dazzling. Good light transmission without dark area

İşık eşit, göz kamaştırıcı değil, parlama önleyici, iyi ışık geçirgenliği ve karanlık alan yok



HZ-6H1-116x20x12.7

Boyut	116*20*12.7MM
Açı	45°
Malzeme	PC
Işık kaynağı	3030/5050
Lamba boncukları	6
Davlumbaz rengi :	<input type="radio"/> <input checked="" type="radio"/> <input type="radio"/> <input type="radio"/> <input type="radio"/> <input type="radio"/>



HZ-6H1-30x157.2

Boyut	30*157.2MM
Açı	45/75°
Malzeme	PC
Işık kaynağı	3030/3535/5050
Lamba boncukları	6

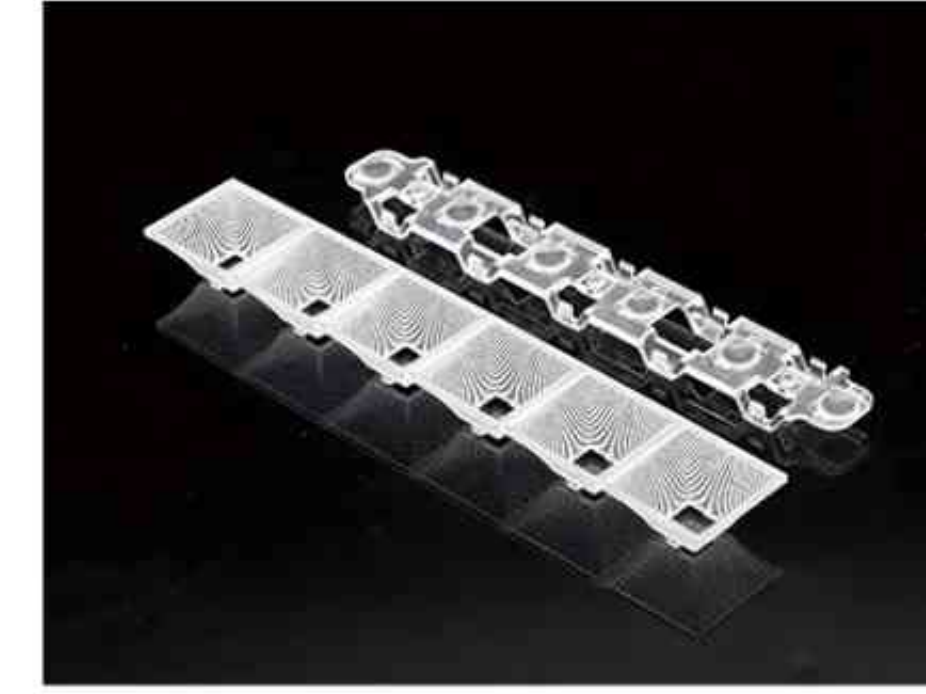

HZ-6H1-30x180x15.4

Boyut	30*180*H15.4MM
Açı	60/85°
Malzeme	PC
Işık kaynağı	2835/3030/3535
Lamba boncukları	6
Davlumbaz rengi :	<input type="radio"/> <input type="radio"/> <input checked="" type="radio"/> <input type="radio"/>



HZ-6H1-120x20x16.5

Boyut	120*20*H16.5MM
Açı	24/50°
Malzeme	PC
Işık kaynağı	2835/3030/3535
Lamba boncukları	6
Davlumbaz rengi :	<input type="radio"/> <input checked="" type="radio"/> <input type="radio"/> <input type="radio"/> <input type="radio"/> <input type="radio"/>



HZ-14H1-280x20x16.5

Boyut	280*20*16.5MM
Açı	24/50°
Malzeme	PC
Işık kaynağı	2835/3030/3535
Lamba boncukları	14
Davlumbaz rengi :	<input type="radio"/> <input checked="" type="radio"/> <input type="radio"/> <input type="radio"/> <input type="radio"/> <input type="radio"/>

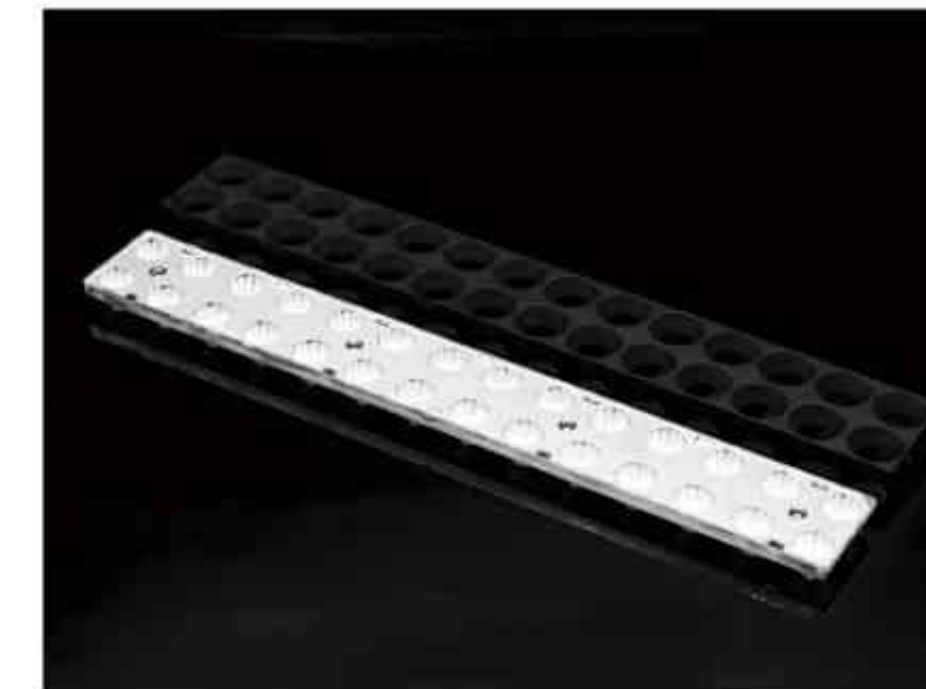

HZ-28H1-280x40x16.5

Boyut	280*40*16.5MM
Açı	24/50°
Malzeme	PC
Işık kaynağı	2835/3030/3535
Lamba boncukları	28
Davlumbaz rengi :	<input type="radio"/> <input checked="" type="radio"/> <input type="radio"/> <input type="radio"/> <input type="radio"/> <input type="radio"/>



HZ-7H1-279x40x35

Boyut	279*40*35MM
Açı	75°
Malzeme	PC/PMMA
Işık kaynağı	3030
Lamba boncukları	7
Davlumbaz rengi :	<input type="radio"/> <input checked="" type="radio"/> <input type="radio"/> <input type="radio"/> <input type="radio"/> <input type="radio"/>



LED line light lens series LED ÇIZGI IŞIK LENSİ

.....
Led optical lens indoor lighting series wall lights, hanging lights,
magnetic rail lights

LED optik lens kapalı aydınlatma serisi duvar lambası, asılı lamba, manyetik
parça lambası



HZ-13-160D

Boyut	Φ13MM
Açı	160°
Malzeme	PC
Işık kaynağı	2835



HZ-19-H14.6-7D

Boyut	Φ19*H14.6MM
Açı	7°
Malzeme	PMMA
Işık kaynağı	2835/3030

Açısal dağılım

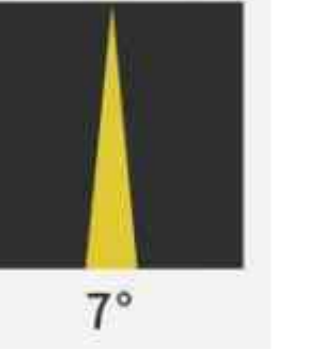

HZ-19-H14.6

Boyut	Φ19*H14.6MM
Açı	10x34°/15°/30°/60°
Malzeme	PMMA
Işık kaynağı	2835/3030

Açısal dağılım

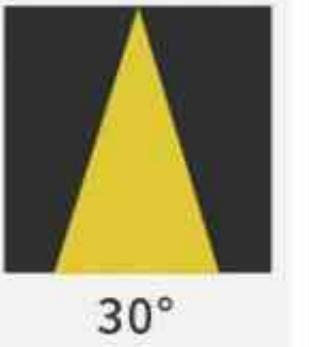

HZ-21-H13

Boyut	Φ21*H13MM
Açı	5°/10°/25°/45°/60°
Malzeme	PMMA
Işık kaynağı	XPE-3535

Açısal dağılım

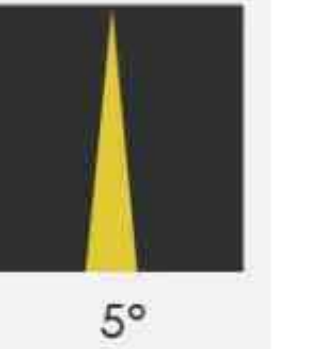

HZ-22-H11.45

Boyut	Φ22*H11.45MM
Açı	15°/10x60°/20x40°/30°
Malzeme	PC
Işık kaynağı	2835/3030/3535



HZ-50X20-H8-30X45D

Boyut	50*20*8MM
Açı	30°/45°
Malzeme	PC/PMMA
Işık kaynağı	XPE-3030
Lamba boncukları	3



Anti-glare cover Optik parlama önleyici maske serisi

Çeşitli renkler mevcuttur
A variety of colors to choose from



Mat siyah
Matte black



Mat beyaz
Matte white



Mat gümüş
Matte silver



Silah siyahı
Gun black



Altın
Gold



Argent
Silver

Parlama önleyici maske özellikleri Anti-glare cover specifications

Flat / Düz ağız	Bevel / Eğimli
<p>Ø136 59</p>	<p>Ø87 32</p>
<p>Ø115 48</p>	<p>Ø68 26</p>
<p>Ø88 38</p>	<p>Ø50 18</p>
<p>Ø68 29</p>	

Unit of measure (mm)

Ölçü birimi (mm)

Colorful colors and various specifications to create your own eye protection environment

Çeşitli renkler ve özellikler kendi göz dostu ortamınızı yaratır



optical lens
Optik lensler

lens holder
Lens çerçeveleri

light source bracket
Işık kaynağı braket

COB LENS SERISI

cob Lens series

COB spotlights, trunk lights, track lights and other lighting lenses

COB spot ışıkları, bagaj lambaları, ray lambaları ve diğer aydınlatma lensleri



HZ-43-H16-A

Boyut	Ø43*H16MM	Açısal dağılım		
Açı	15°/24°/36°			
Malzeme	PMMA	15°	24°	36°
Işık kaynağı	CXM-6/9/11			
Parantez	1313/1507			



HZ-50-H19-A

Boyut	Ø50*H19MM	Açısal dağılım		
Açı	15°/24°/36°			
Malzeme	PMMA	15°	24°	36°
Işık kaynağı	CXM-6/9/11			
Parantez	1313/1507			



HZ-60-H24-A

Boyut	Ø60*H24MM	Açısal dağılım		
Açı	15°/24°/36°			
Malzeme	PMMA	15°	24°	36°
Işık kaynağı	020/030/CXM-9/11/14/16			
Parantez	1313/1507/1830/1919			



HZ-69-H30-A

Boyut	Ø69*H30MM	Açısal dağılım		
Açı	15°/24°/36°			
Malzeme	PMMA	15°	24°	36°
Işık kaynağı	020/030/CXM-9/11/14/16			
Parantez	1313/1507/1830/1919			



HZ-69-H30-RGB

Boyut	Ø69*H30MM	Açısal dağılım	
Açı	15°/24°		
Malzeme	PMMA	15°	24°
Işık kaynağı	CXM-11/14/16/RGB		
Parantez	1313/1507/1830/1919		



Ultra ince COB lens serisi Ultra-thin COB lens series



PMMA Emissive Surface 10 Matching Brackets Precision
Machining Small Molecular Optics



HZ-35-H10

Boyut	Ø35*H10MM
Açı	15°/24°/36°/60°
Malzeme	PMMA
Işık kaynağı	CXM-6
Parantez	Eşleşen (Normal)



HZ-44-H11.3

Boyut	Ø44*H11.3MM
Açı	15°/24°/36°/60°
Malzeme	PMMA
Işık kaynağı	CXM-6
Parantez	Eşleşen (Normal)



HZ-50-H14

Boyut	Ø50*H14MM
Açı	15°/24°/36°/60°
Malzeme	PMMA
Işık kaynağı	CXM-10
Parantez	Eşleşen (Normal)



HZ-55-H15

Boyut	Ø55*H15MM
Açı	15°/24°/36°/60°
Malzeme	PMMA
Işık kaynağı	CXM-10
Parantez	Eşleşen (Normal)



HZ-62-H17.5

Boyut	Ø62*H17.5MM
Açı	15°/24°/36°/60°
Malzeme	PMMA
Işık kaynağı	CXM-10
Parantez	Eşleşen (Normal)



HZ-70-H18.5	
Boyut	Ø70*H18.5MM
Açı	15°/24°/36°/60°
Malzeme	PMMA
Işık kaynağı	CXM-14
Parantez	Eşleşen (Normal)



HZ-75-H21.5	
Boyut	Ø75*H21.5MM
Açı	15°/24°/36°/60°
Malzeme	PMMA
Işık kaynağı	CXM-14
Parantez	Eşleşen (Normal)



HZ-83-H22	
Boyut	Ø83*H22MM
Açı	15°/24°/36°/60°
Malzeme	PMMA
Işık kaynağı	CXM-14
Parantez	Eşleşen (Normal)

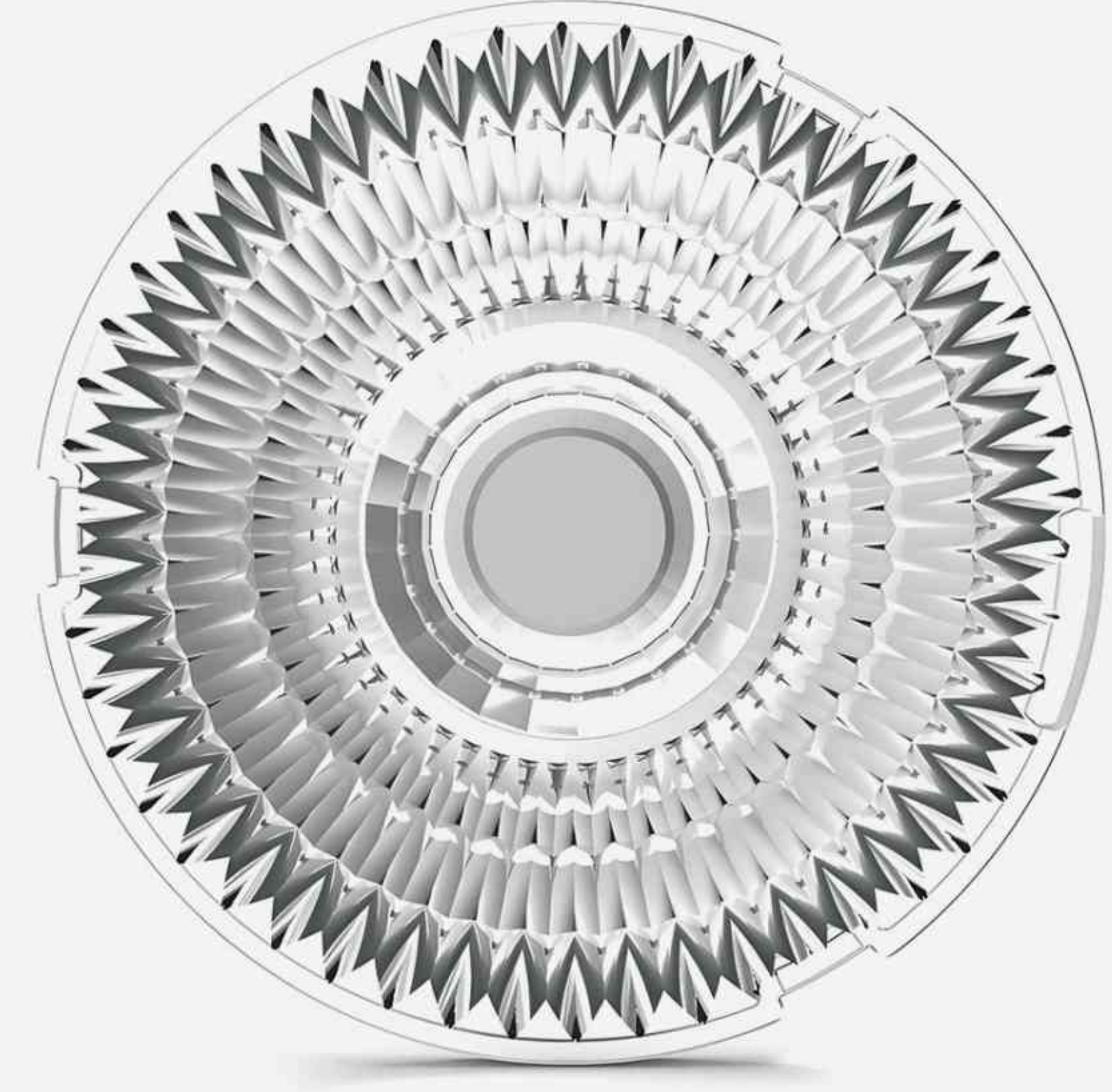
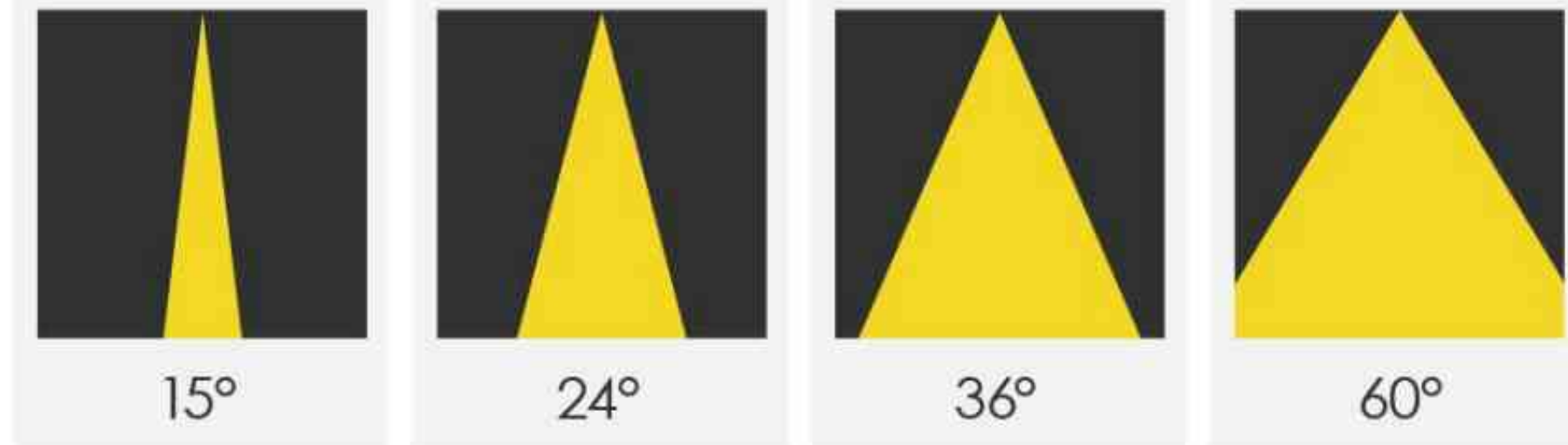

Ultra-thin design
gives you more lighting design inspiration

İnce tasarım, aydınlatma tasarımı için size daha fazla ilham verir



HZ-68-H18	
Boyut	Ø68*H18MM
Açı	15°/24°/36°/60°
Malzeme	PC
Işık kaynağı	Cree CMD-1818-12mm
Parantez	Eşleşen (Normal)



Stage lights Illumination lens Sahne aydınlatması aydınlatma lensleri



AYDINLATMA
Stage lighting



BAR AYDINLATMASI
Bar lighting



DÜĞÜN AYDINLATMASI
Wedding lighting



HZ-35-H15.8

Boyut	Ø35*H15.8MM
Malzeme	PMMA
Açı	24°/36°
Işık kaynağı	5050-RGB

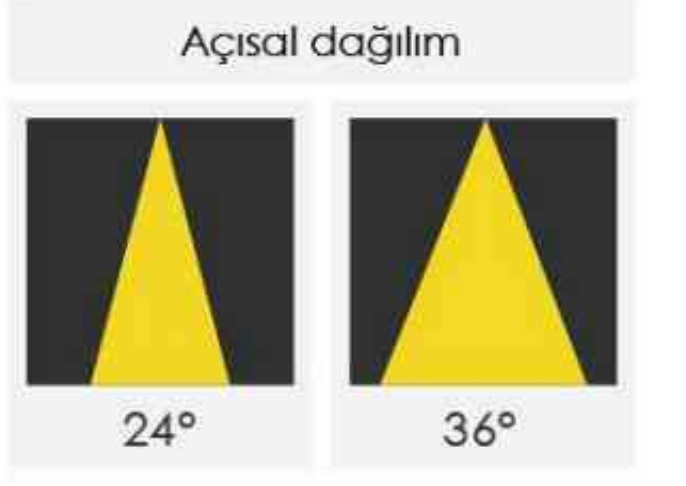

HZ-45-H26

Boyut	Ø45*H26MM
Malzeme	PMMA
Açı	7°
Işık kaynağı	XML-5050



HZ-45-H26-2

Boyut	Ø45*H26MM
Malzeme	PMMA
Açı	10°/15°/24°
Işık kaynağı	XML-5050-RGBW



HZ-69-H30-RGB

Boyut	Ø69*H30MM
Malzeme	PMMA
Açı	15°/24°
Işık kaynağı	CXM-11/14/16/RGB
Parantez	1313/1507/1830/1919

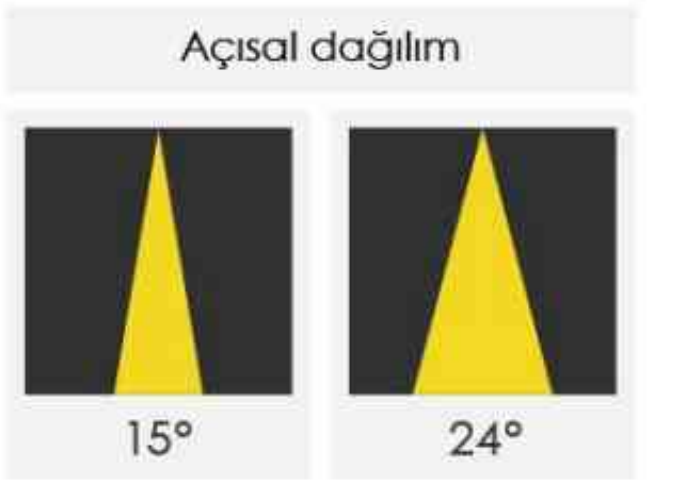

HZ-35-H18

Boyut	Ø35*H18MM
Malzeme	PMMA
Açı	7°
Işık kaynağı	3535



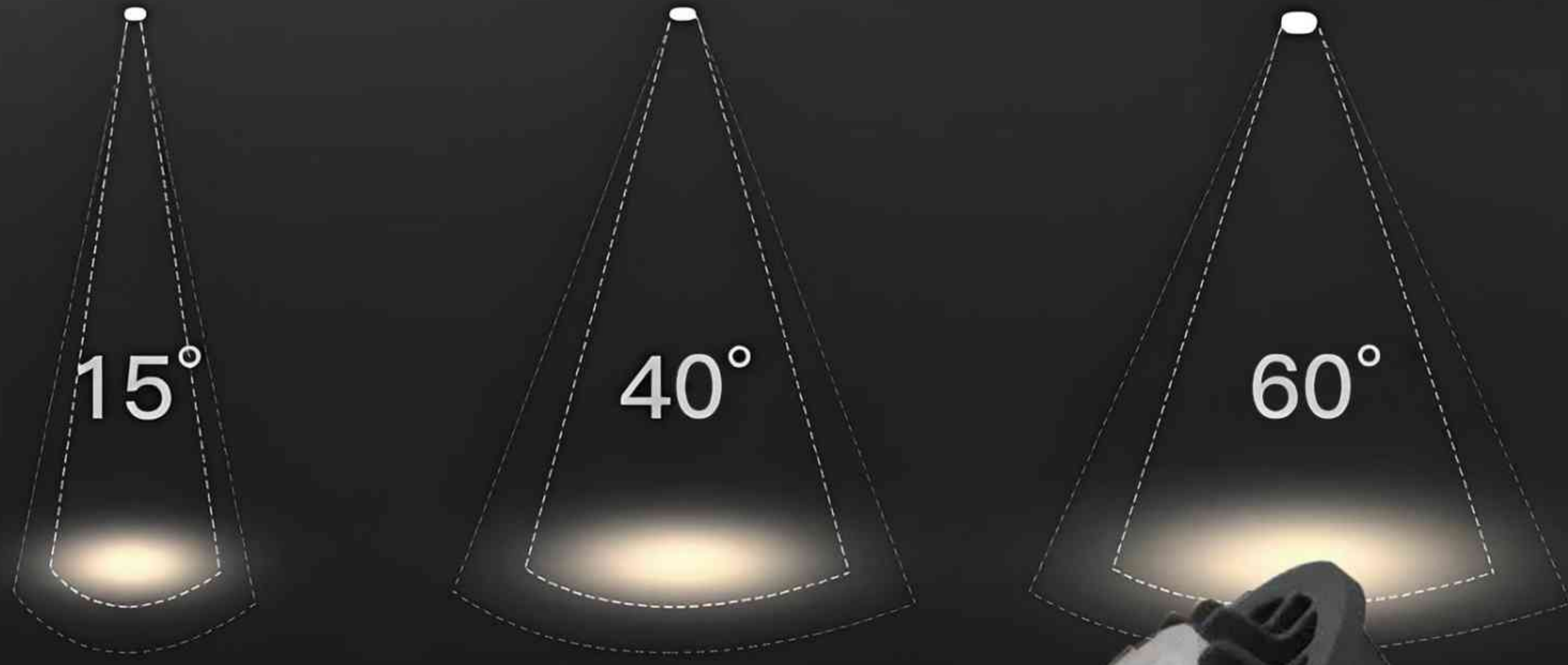

GU10 MR11 MR16 MERCEK GU10 MR11 MR16 LENS

LED Indoor Lighting Optical Lenses
LED İç Mekan Aydınlatma Optik Lensleri



HZ-31-H8.7		
Boyut	Açı	Açısal dağılım
Ø31*H10MM	36°	
Malzeme	Işık kaynağı	
PMMA	CXM-11	36°



HZ-35-H8.7		
Boyut	Açı	Işık kaynağı / Açısal dağılım
Ø35*H8.7MM	20°	  
Malzeme		
PMMA		3535 20°

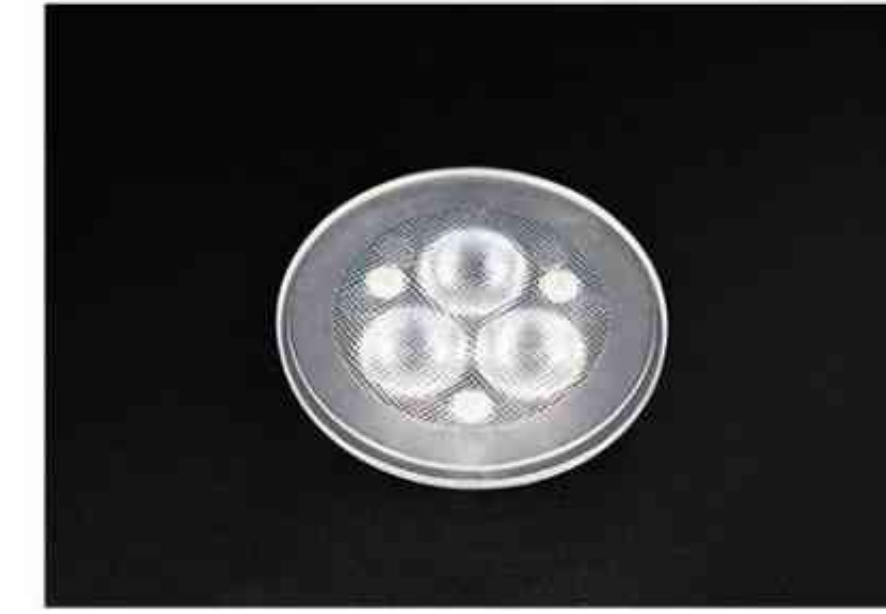

HZ-35-H8.7-2		
Boyut	Açı	Işık kaynağı / Açısal dağılım
Ø35*H8.7MM	30°/60°	   
Malzeme		
PMMA		30° 60°



HZ-42-H14		
Boyut	Açı	Açısal dağılım
Ø42*H14MM	24°	
Malzeme	Işık kaynağı	
PMMA	CXM-11	24°



HZ-42-H14		
Boyut	Açı	
Ø42*H14MM	15°/24°/40°/60°	
Malzeme	Işık kaynağı	
PMMA	CXM-11	



HZ-43-H10		
Boyut	Açı	Açısal dağılım
Ø43*H10MM	40°	
Malzeme	Işık kaynağı	
PMMA	CXM-11	40°



HZ-43-H20		
Boyut	Açı	
Ø43*H20MM	36°	
Malzeme	Işık kaynağı	
PC	1507	



HZ-50-H19		
Boyut	Açı	
Ø50*H19MM	36°	
Malzeme	Işık kaynağı	
PC	1507	



Two-color downlight lens
İki renkli downlight lens

••••

Yüksek ışık geçirgenliği, net ve parlak ışık ve iyi genel yansıtma

High light transmittance, clear and bright light good overall reflectivity



HZ-43-H11.45

Boyut $\varnothing 43 \times H14.5MM$

Açı 50°

Malzeme PC/PMMA

Işık kaynağı 2835 iki renkli (2835 Two-color)

50°



HZ-48-H20

Boyut $\varnothing 48 \times H20MM$

Açı 40°

Malzeme PC/PMMA

Işık kaynağı 2835 iki renkli (2835 Two-color)

40°



Facing ring
Alüminyum yüz halkaları



Optical lens
Optik lensler

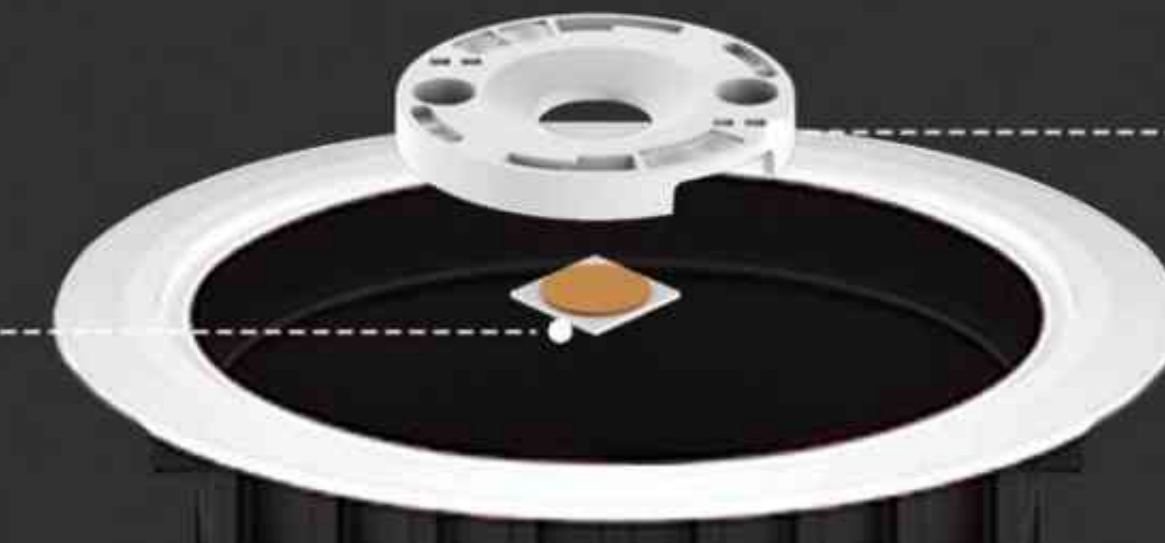

Bracket
Parantez

Light source
Işık kaynağı



Heat sink
Heat sink